

 **ЭЛЕМЕР**
Science-production enterprise

ELECTRONIC MANOMETER
ЭКМ-2005

Operation manual
HKГЖ.406233.036PЭ



CONTENT

1	Introduction	3
2	Description and operation	3
2.1	Function of the instrument	3
2.2	Specification	11
2.3	Design and operation	29
2.4	Menu navigation.	36
2.5	Setting configuration parameters of ЭКМ.	41
2.6	Assigning settings values, settings test	46
2.7	Error reporting	48
2.8	Marking	48
2.9	Packaging	48
3	Use of instruments according to function	49
3.1	Preparation of instruments for operation	49
3.2	Use of instruments	59
4	Calibration methods	62
5	Technical maintenance	69
6	Storing	70
7	Transportation	70
8	Utilization	70
	Appendix А Example of recording of designation when ordering	71
	Appendix Б Tags with marking	77

1. INTRODUCTION

1.1. Operation manual contains information on design and operation principles, specifications of electronic manometers ЭКМ-2005 and instructions required for their correct and safe operation

2. DESCRIPTION AND OPERATION

2.1 Function of the instrument

2.1.1 Electronic manometers ЭКМ-2005 (hereinafter – ЭКМ) are designed for measuring and supervision of values of absolute pressure, overpressure, excessive expansion pressure and pressure difference of liquid and gaseous media including aggressive medium.

ЭКМ is used in the system of automatic monitoring, regulation and controlling of technological processes.

ЭКМ may contain a converter of measured value into unified output current signal of 0...5, 0...20 or 4...20 mA.

ЭКМ is produced in four versions:

- ЭКМ-2005-ДА – manometers of absolute pressure;
- ЭКМ-2005-ДИ – manometers of overpressure;
- ЭКМ-2005-ДИВ – manometers of overpressure – expansion pressure;
- ЭКМ-2005-ДД – manometers of pressure difference.

ЭКМ have versions presented in the table 2.1.

Table 2.1 - Version

Version	Code of version	Code when ordering
General industrial	-	-
Nuclear of improved reliability	A	A
Nuclear with Rostechnadzor acceptance	A	NPS

Power supply voltage of ЭКМ is commutated by the signaling devices of ЭКМ, 220 V of alternate or direct current, 24 V (36 v) direct current. Signaling devices commute one of power supply voltage inputs at outputs of signaling channels.

ЭКМ may perform signaling function and automatic regulation of controlled parameters with the help of signaling devices.

Signaling devices provide commutation:

- of alternate current of circuit frequency:

- at voltage of 250 V to 5 A for active load,
 - at voltage of 250 V to 1 A for inductive load ($\cos \varphi \geq 0,4$);
 - direct current:
 - at voltage of 250 V to 0,1 A for active and inductive loads,
 - at voltage of 40 V до 2 A for active and inductive loads;
 - minimal commuted voltage of 18 V at current ≥ 10 mA.
- ЭKM have indicator types of provided in the table 2.1.1.

Table 2.1.1 – Code of the inbuilt indicator type.

Indicator type	Code of indicator type when ordering
LCD negative with lighting (light symbols at the dark background)	LN*
LCD positive with lighting (dark symbols at the light background)	LP
Notes – * Basic version.	

Signaling device connecting external circuits have got four variants of execution according to STATE STANDARDS 2405-88, provided in the table 2.2.

Table 2.2 – Code of execution of signaling device

Code when ordering	Connection of external circuits by STATE STANDARDS 2405-88	Execution version by STATE STANDARDS 2405-88
III	Two break contacts (Two normally closed contacts)	III
IV	Two make contacts (Two normally open contacts)	IV
V*	One break contact, another make contact (First contact is normally closed, second contact normally open)	V
VI	One make contact, another break contact (First contact is normally open, second contact is normally closed)	VI
Notes – * Basic version		

ЭKM are instruments reconfigured by consumers, with indication of current value of converted value. Reading and changing configuration parameters of ЭKM is performed with the aid of a keypad. Indication of the value of the measured value, measuring units, settings, configuration parameters and information on relay operation of signaling channels is performed on the combined LCD display (LCD - indicator) with lighting. Measured value is reflected simultaneously at the four digit digital indicator in the form of discrete graphic scale with indication of settings position relative to measuring range.

ЭКМ have two settings and two electromechanical vibration-proof relay (hereinafter - relay) of signaling channels, type and value of settings is selected by the consumer.

2.1.2 In accordance with STATE STANDARDS 22520-85 ЭКМ is:

- by the number of converted input and output signals – one channel;
- by dependence of output signal on input signal – with linear dependence or function of square rooting;
- by possibility of restructuring of measuring range – to multirange, recalibratable.

2.1.3 ЭКМ is configured with the help of incorporated three-key keyboard, located on the front panel.

2.1.4 Rating upper and lower measuring limits as well as displayed value may be performed in the following units (designation of measuring units, displayed on the display of ЭКМ, provided in brackets):

- kPa (kPa), МПа (MPa), кгс/см² (kgf/cm²);
- by special order: bar, atm, mm of water column, Pa, mm of mercury column.

Note – Ordered units are not indicated on the LCD display.

2.1.5 When connecting ЭКМ to direct current voltage sources polarity of connection has no importance.

2.1.6 ЭКМ-2005A (improved reliability) is used as a component of the control system of technological processes of nuclear power stations.

2.1.6.1 ЭКМ-2005A in accordance with STATE STANDARDS 25804.1-83:

- by nature of operation is referred to Б category – instruments of continuous operation;
- by number of levels of quality of operation it belongs to the type I – instruments possessing two levels of operation quality – nominal level and failure.

2.1.6.2 ЭКМ-2005A according to conditions of operation in NPS belong to location groups 1.3, 1.4, 2.1-2.3 in accordance with the table 6.1 CTO 1.1.1.07.001.0675-2008.

2.1.6.3 ЭКМ-2005A corresponds to the version УХЛ3.1 according to STATE STANDARDS 15150-69 (for location group 1.3, 1.4, 2.1, 2.2, and for location group 2.3 - УХЛ4.1) with distinguishing impact factors, provided in appendix A CTO 1.1.1.07.001.0675-2008, but in expanded temperature area of ambient air, provided in item 2.1.9 of the present manual.

2.1.6.4 ЭКМ-2005A corresponds to the type of climatic version TB4.1 according to STATE STANDARDS 15150-69 in accordance with R01.KK.0.0.AP.TT.WD001 they are operational at the ambient air temperature from plus 5 till plus 50 °C, as well as during 6 hours at maximal temperature of ambient air from plus 1 to plus 60 °C and relative air humidity up to 98 % at temperature 35 °C and lower temperatures without humidity condensation.

2.1.6.5 ЭКМ-2005А corresponds to requirements of reliability CTO 1.1.1.07.001.0675-2008 and requirements of item 2.2.47 of the present operation manual.

2.1.6.6 ЭКМ-2005А corresponds to requirements of decontamination CTO 1.1.1.07.001.0675-2008 and requirements of item 2.2.45 of the present operation manual.

2.1.6.7 ЭКМ-2005А correspond to qualification category R1, R2, R3, R4 (depending on the version) in accordance with item 6.4 CTO 1.1.1.07.001.0675-2008.

2.1.6.8 ЭКМ-2005А should be accepted in accordance with requirements CTO 1.1.1.07.001.0675-2008.

2.1.6.9 According to resilience to mechanical impact during operation of ЭКМ-2005 belong to the group of execution M6 according to STATE STANDARDS 17516.1-90.

2.1.6.10 ЭКМ-2005А belong to the I category seismic stability by НП-031-01 and to the group Б of execution 3 by РД 25 818-87.

ЭКМ-2005А is durable, stable and resilient to earthquake impact with resistance to earthquake intensity of 8 points level of seismicity MSK-64 over the zero mark over 40 m in accordance with STATE STANDARDS 25804.3-83.

2.1.6.11 ЭКМ-2005А (of improved reliability) in accordance with НП – 001 – 97 (ОПБ – 88/97) belongs to the safety categories 2, 3, 4:

- according to purpose – to elements of general operation;
- according to influence on safety – to elements, important for safety;
- according to the character of functions performed – to elements of safety controlling systems.

Example of classification designation 2HY, 3H or 4H.

2.1.6.12 ЭКМ-2005А according to immunity to environmental impact according to STATE STANDARD 15150-69:

- is manufactured in corrosion proof version T III;
- is designed for operation at Nuclear Plant (for the type of atmosphere III), resilient to content of corrosion-active agents in atmosphere in the open air, characterized by the following parameters:

Substance	Concentration, mg/m ³	Rate of precipitation sm/s	Precipitation flow, mg/(m ² ·day)
Chlorides	0,0212	0,1	1,83
Sulfates	0,58	0,1	50
Sulfurous gas	0,006	0,9	4,7
Nitrogen oxides	0,004	-	-

2.1.7 ЭКМ according to resilience to electromagnetic interference corresponds to the IV execution group, to quality of functioning criteria - A according to STATE STANDARDS P 50746-2000. Main types of electromagnetic interference are provided in the table 2.3.

Table 2.3 — Resistance of ЭКМ-2005 to electromagnetic interferences
(ЭКМ-2005 with power supply from net 220 V)

Degree of rigidity of electromagnetic situation according to State Standards	Characteristics of interferences types	Value	Execution group	Quality criteria of functioning according to State Standards P 50746
3 ГОСТ P 51317.4.5	Microsecond pulse interferences of high energy (МИП): - signal terminals, control terminals, terminals of input-output («wire-ground»)	2 kV	IV	A
3 ГОСТ P 1317.4.5	Microsecond pulse interference of high energy (МИП): - input and output terminals - terminals of electrical power supply of alternate current, interference supply:	(«wire-ground») 2 kV	IV	A
4 ГОСТ P 1317.4.5		(«wire-ground») 4 kV		
4 ГОСТ P 1317.4.4	Nanosecond pulse interference (НИП): - signal terminals, control terminals, input-output terminals	2 kV	IV	A
	Nanosecond pulse interference (НИП): - input and output terminals of electric power supply of electrical power supply of alternate current power supply	4 kV	IV	A
4 ГОСТ P 51317.4.2	Electrostatic discharges: - contact discharge - air discharge	8kV 15 kV	IV	A
5 ГОСТ P 50648	Magnetic field of industrial frequency: - long time magnetic field - short time magnetic field 3 sec	40 A/m 600 A/m	IV	A
5 ГОСТ P 50649	Pulse magnetic field	600 A/m	IV	A
3 ГОСТ P 51317.4.3	Radiofrequency electromagnetic fields in frequency band: - 80-1000 MHz	10 B/m	IV	A
4 ГОСТ P 51317.4.3	- 800-960 MHz - 1400-2000 MHz	30 B/m	IV	A
3 ГОСТ P 51317.4.6	Conductive interferences in the frequency band: 0,15-80 MHz: - input-output circuits - power supply circuits	10 V 10 V	IV IV	A A
4 ГОСТ P 51317.4.11	Dynamic changes of power supply voltage: - voltage depressions	$\frac{70}{100/2000}$	IV	A
3 ГОСТ P 51317.4.11	- voltage interruption	$\frac{0}{10/200}$		
4 ГОСТ P 51317.4.11	- voltage surges	$\frac{120}{100/2000}$		
5 ГОСТ P 50652	Damped oscillation magnetic field 100 kHz	100 A/M	IV	A
4 ГОСТ P 51317.4.12	Single oscillation damped interferences at input terminals of power supply of alternate current by circuit:	(«ground-wire») 2 kV	IV	A
		(«wire-ground») 4 kV		

Continuation of the table 2.3

Degree of rigidity of electromagnetic situation according to State Standards	Characteristics of interferences types	Value	Execution group	Quality criteria of functioning according to State Standards P 50746
STATE STANDARDS P 51317.4.13	Distortion of sinusoidal voltage of power supply	-	IV	Corresponds for TC* grade A**
Special STATE STANDARDS P 51317.4.14	Oscillations of power supply voltage	$\pm 0,2U_{\text{НОМ}}$	IV	A
3 STATE STANDARDS P 51317.4.28	Variation of frequency in systems of power supply	$\pm 15\%$ of $U_{\text{НОМ}}$	IV	A
STATE STANDARDS P 51318.22	Emission of industrial interference at a distance of 10 m: - in frequency range 30-230 MHz into surrounding space	40 dB	-	Corresponds to TC* grade A**
STATE STANDARDS P 51318.22	Emission of industrial interference at a distance of 10 m: - in frequency range 230-1000 MHz into surrounding space	47 dB	-	Corresponds to TC* grade A**
	Emission of voltage industrial interferences - in frequency range 0,15 MHz - in frequency range 0,5-30	79 dB 73 dB	-	
STATE STANDARDS P 51317.3.2	Harmonic components of consumed current	-	-	Corresponds to TC* grade A**
STATE STANDARDS P 51317.3.3	Voltage oscillation, caused by TC AC	-	-	Corresponds to TC* grade A**
<p>Notes 1 * TC – technical means. 2 ** Grade A – equipment category according to STATE STANDARDS P 51318.22-99. 3 ЭКМ functions normally and do not cause interferences in conditions of joint operation with equipment of systems and components, for which they are designed, as well as with equipment of another purpose, which may be used together with ЭКМ in a typical interference situation.</p>				

Table 2.3.1 – Stability of ЭКМ-2005 to electromagnetic interferences (ЭКМ-2005 with power supply from the direct current power supply 36 V)

Degree of rigidity of electromagnetic situation according to State Standards	Characteristics of interferences types	Value	Execution group	Quality criteria of functioning according to State Standards P 50746
3 STATE STANDARDS P 51317.4.5	Microsecond pulse interferences of high energy (МИП): - Amplitude of interferences pulses in the input-output (wire-ground)	2 kW	IV	A
2 STATE STANDARDS P 51317.4.5	Microsecond pulse interferences of high energy (МИП): (ground-wire)	1 kW	IV	A
3 STATE STANDARDS P 51317.4.5	- Amplitude of interference pulses in the circuit of direct current power supply (wire-ground)	2 kW	IV	A
4 STATE STANDARDS P 51317.4.4	Nanoseconds of pulse interferences (НИП): - circuits of input-output	2 kW	IV	A
3 STATE STANDARDS P 51317.4.4	- Nanoseconds of pulse interferences (НИП): input circuits of direct current power supply	2 kW	IV	A

Продолжение таблицы 2.3.1

Degree of rigidity of electromagnetic situation according to State Standards	Characteristics of interferences types	Value	Execution group	Quality criteria of functioning according to State Standards P 50746
4 STATE STANDARDS P 51317.4.2	Electrical discharges: - contact discharge - air discharge	8 kW	IV	A
		15 kW	IV	A
3 STATE STANDARDS P 51317.4.3	Radiofrequency electromagnetic fields in frequency range: - 80-1000 MHz	10 V/m	IV	A
4 STATE STANDARDS P 51317.4.3	- 800-960 MHz - 1400-2000 MHz	30 V/m	IV	A
3 STATE STANDARDS P 51317.4.6	Conductive interferences in frequency range: - 0,15-80 MHz *	10 V	IV	A
5 STATE STANDARDS P 50648	Magnetic field of industrial frequency long time magnetic field	40 V/m	IV	A
5 STATE STANDARDS P 50648	Magnetic field of industrial frequency short time magnetic field 3 s	600 A/m	IV	A
5 STATE STANDARDS P 50649	Pulse magnetic field	600 A/m	IV	A
5 STATE STANDARDS P 50652	Damped oscillation magnetic field 100 kHz	100 A/m	IV	A
STATE STANDARDS P 51318.22	Emission of industrial interferences at distance of 10 m: - in the frequency range of 30-230 Mhz in surrounding space	40 dB	-	Corresponds to TC** grade A***
STATE STANDARDS P 51318.22	Emission of industrial interferences at distance of 10 m: - in the frequency range of 230-1000 MHz in surrounding space	47 dB	-	Corresponds to TC** grade A***
Note 1 *Additional error 1,4 % from the range of the output signal in the range of frequencies (6,6±0,1) MHz. 2 **TC – technical means. 3 *** Grade A – category of equipment according to STATE STANDARDS P 51318.22-99. 4 ЭКМ normally functions and do not create interferences in conditions of joint operation with equipment of systems and components, for which it is designed, as well as with equipment of different purpose, which may be used together with the present ЭКМ in typical interference situation.				

2.1.8 ЭКМ as to its protection from impact of surrounding media in accordance with STATE STANDARDS 14254-96 has the protection degree from dust and water penetrating inside of the converters provided in the table 2.4

Table 2.4 – Code of variants of electrical connection and protection degree from dust and water penetrating inside

Code when ordering	Variants of electrical connection		Degrees of protection according to STATE STANDARDS 14254	Execution versions
	Foodchain and signaling	Chain of current output		
GSP*	Plug GSP 311	-	IP65	ЭKM-2005 ЭKM-2005A
GSP*	Plug GSP 311	Plug GSSNA 300		
ШП	Plug 2PMГ22	-		
ШП	Plug 2PMГ22	Plug 2PMГ14		
Note –* Basic version				

2.1.9 ЭKM are stable to climatic impact during operation in accordance with tables 2.5 и 2.5.1.

Table 2.5 – Climatic version for ЭKM-2005

GROUP	STATE STANDARDS	Range of temperature of ambient air	Code when ordering
C3*	12997-84	from minus 5 to plus 50 °C	t0550
C3**		from minus 25 to plus 70 °C	t2570
C2***		from minus 40 to plus 70 °C	t4070
Notes 1 * Basic version. 2 ** Except for model ДМ40. 3 *** For models АМХХХ, ИМХХХ, ВМХХХ.			

Table 2.5.1 – Climatic version for ЭKM-2005A

Groups of execution according to STATE STANDARDS 12997-84	Type of execution according to STATE STANDARDS 15150-69	Group of location according to СТО 1.1.1.07.001.0675-2008	Temperature range of ambient air		Code when ordering***
			Lower value	Upper value	
C3*	УХЛ3.1*	1.3, 1.4, 2.1, 2.2	-25	+70	t2570
C3	УХЛ4.1*	2.3	-5	+50	t0550
B4**	ТВ4.1**		+5	+50	t0550
C2****	У1*		-40	+70	t4070
Notes 1 * This version has extended range of temperatures. Distinctive affecting factors in accordance with Appendix A СТО 1.1.1.07.001.0675-2008. Except for model ДМ40. 2 ** This version has extended range of temperatures. This model keeps operating during 6 hours at maximal temperature values of ambient air from plus 1 to plus 60 °C and relative humidity of air up to 98 % at the temperature of 35 °C and lower temperatures without humidity condensation. 3 *** Additionally the climatic version is indicated (type or group). 4 **** For models АМХХХ, ИМХХХ, ВМХХХ.					

2.2 Specifications

2.2.1 Maximal upper limit of measuring (reference designation of a model), limits of tolerable basic reduced errors, presented in percentage from the upper measuring range, correspond to the one presented in tables 2.6 – 2.12.

Maximal (test) pressure and tolerable operational excessive pressure are presented in tables 2.6 – 2.12.

Reference designation of the model consists of two letters and a figure. The first letter denotes the type of measured pressure:

- A – absolute pressure;
- И – excessive pressure;
- В – excessive pressure-depression;
- Д – pressure difference.

The second letter denote the material of membrane:

- М – metal;
- К – ceramics.

The number in designation of the model corresponds to maximal upper limit measured in units kPa (MPa).

Table 2.6 – Manometers ЭКМ-2005-ДА, ЭКМ-2005А-ДА

Reference designation of the model	Row of upper limits of measurement according to STATE STANDARDS 22520-85	Maximal (test) pressure		Limits of tolerable basic reduced error γ , %, for the precision grade		
		value	%	B**	C**	D**
AK250	60 kPa	1200 kPa	2000	$\pm(0,6+^*)$	$\pm(1,0+^*)$	$\pm(1,5+^*)$
	100 kPa		1200	$\pm(0,5+^*)$	$\pm(0,8+^*)$	$\pm(1,2+^*)$
	160 kPa		750	$\pm(0,4+^*)$	$\pm(0,6+^*)$	$\pm(1,0+^*)$
	250 kPa		450	$\pm(0,25+^*)$	$\pm(0,4+^*)$	$\pm(0,6+^*)$
AK600	160 kPa	2500 kPa	1550	$\pm(0,6+^*)$	$\pm(1,0+^*)$	$\pm(1,5+^*)$
	250 kPa		1000	$\pm(0,5+^*)$	$\pm(0,8+^*)$	$\pm(1,2+^*)$
	400 kPa		600	$\pm(0,4+^*)$	$\pm(0,6+^*)$	$\pm(1,0+^*)$
	600 kPa		400	$\pm(0,25+^*)$	$\pm(0,4+^*)$	$\pm(0,6+^*)$
AK1,6M	0,4 MPa	5 MPa	1250	$\pm(0,6+^*)$	$\pm(1,0+^*)$	$\pm(1,5+^*)$
	0,6 MPa		800	$\pm(0,5+^*)$	$\pm(0,8+^*)$	$\pm(1,2+^*)$
	1,0 MPa		500	$\pm(0,4+^*)$	$\pm(0,6+^*)$	$\pm(1,0+^*)$
	1,6 MPa		300	$\pm(0,25+^*)$	$\pm(0,4+^*)$	$\pm(0,6+^*)$
AK2,5M	0,6 MPa	5 MPa	800	$\pm(0,6+^*)$	$\pm(1,0+^*)$	$\pm(1,5+^*)$
	1,0 MPa		500	$\pm(0,5+^*)$	$\pm(0,8+^*)$	$\pm(1,2+^*)$
	1,6 MPa		300	$\pm(0,4+^*)$	$\pm(0,6+^*)$	$\pm(1,0+^*)$
	2,5 MPa		200	$\pm(0,25+^*)$	$\pm(0,4+^*)$	$\pm(0,6+^*)$
AK6M	1,6 MPa	12 MPa	750	$\pm(0,6+^*)$	$\pm(1,0+^*)$	$\pm(1,5+^*)$
	2,5 MPa		450	$\pm(0,5+^*)$	$\pm(0,8+^*)$	$\pm(1,2+^*)$
	4,0 MPa		300	$\pm(0,4+^*)$	$\pm(0,6+^*)$	$\pm(1,0+^*)$
	6,0 MPa		200	$\pm(0,25+^*)$	$\pm(0,4+^*)$	$\pm(0,6+^*)$

Notes

1 * One unit of the last digit, presented in percentage from the measuring range.

2 ** Reference designation of the precision grade.

3 By demand of a consumer it is possible to manufacture ЭКМ with different upper measurement limits.

Table 2.7 – Electronic manometers ЭКМ-2005-ДА, ЭКМ-2005А-ДА

Reference Designation of a model	Row of upper limits Of measurement according to STATE STANDARDS 22520-85	Maximal (test) pressure		Limits of tolerable basic reduced error γ , %, for precision grade		
		value	%	B**	C**	D**
AM100	25 kPa	500 kPa	2000	$\pm(0,6+^*)$	$\pm(1,0+^*)$	$\pm(1,5+^*)$
	40 kPa		1250	$\pm(0,5+^*)$	$\pm(0,8+^*)$	$\pm(1,2+^*)$
	60 kPa		800	$\pm(0,4+^*)$	$\pm(0,6+^*)$	$\pm(1,0+^*)$
	100 kPa		500	$\pm(0,25+^*)$	$\pm(0,4+^*)$	$\pm(0,6+^*)$
AM250	60 kPa	1200 kPa	2000	$\pm(0,6+^*)$	$\pm(1,0+^*)$	$\pm(1,5+^*)$
	100 kPa		1200	$\pm(0,5+^*)$	$\pm(0,8+^*)$	$\pm(1,2+^*)$
	160 kPa		750	$\pm(0,4+^*)$	$\pm(0,6+^*)$	$\pm(1,0+^*)$
	250 kPa		450	$\pm(0,25+^*)$	$\pm(0,4+^*)$	$\pm(0,6+^*)$
AM600	160 kPa	1200 kPa	750	$\pm(0,6+^*)$	$\pm(1,0+^*)$	$\pm(1,5+^*)$
	250 kPa		450	$\pm(0,5+^*)$	$\pm(0,8+^*)$	$\pm(1,2+^*)$
	400 kPa		300	$\pm(0,4+^*)$	$\pm(0,6+^*)$	$\pm(1,0+^*)$
	600 kPa		200	$\pm(0,25+^*)$	$\pm(0,4+^*)$	$\pm(0,6+^*)$
AM1,6M	0,4 MPa	5 MPa	1250	$\pm(0,6+^*)$	$\pm(1,0+^*)$	$\pm(1,5+^*)$
	0,6 MPa		800	$\pm(0,5+^*)$	$\pm(0,8+^*)$	$\pm(1,2+^*)$
	1,0 MPa		500	$\pm(0,4+^*)$	$\pm(0,6+^*)$	$\pm(1,0+^*)$
	1,6 MPa		300	$\pm(0,25+^*)$	$\pm(0,4+^*)$	$\pm(0,6+^*)$
AM2,5M	0,6 MPa	5 MPa	800	$\pm(0,6+^*)$	$\pm(1,0+^*)$	$\pm(1,5+^*)$
	1,0 MPa		500	$\pm(0,5+^*)$	$\pm(0,8+^*)$	$\pm(1,2+^*)$
	1,6 MPa		300	$\pm(0,4+^*)$	$\pm(0,6+^*)$	$\pm(1,0+^*)$
	2,5 MPa		200	$\pm(0,25+^*)$	$\pm(0,4+^*)$	$\pm(0,6+^*)$
AM6M	1,6 MPa	12 MPa	750	$\pm(0,6+^*)$	$\pm(1,0+^*)$	$\pm(1,5+^*)$
	2,5 MPa		450	$\pm(0,5+^*)$	$\pm(0,8+^*)$	$\pm(1,2+^*)$
	4,0 MPa		300	$\pm(0,4+^*)$	$\pm(0,6+^*)$	$\pm(1,0+^*)$
	6,0 MPa		200	$\pm(0,25+^*)$	$\pm(0,4+^*)$	$\pm(0,6+^*)$

Notes
 1 * One unit of the last digit, presented in percentage of the measurement range.
 2 ** Reference designation of the precision grade.
 3 By demand of a customer it is possible to manufacture ЭКМ with different upper limits of measurements.

Table 2.8 – Electronic manometers ЭКМ-2005-ДИ, ЭКМ-2005А-ДИ

Reference Designation of a model	Row of upper limits Of measurement according to STATE STANDARDS 22520-85	Maximal (test) pressure		Limits of tolerable basic reduced error γ , %, for precision grade		
		value	%	B**	C**	D**
ИК16	4 kPa	40 kPa	1000	$\pm(0,6+^*)$	$\pm(1,0+^*)$	$\pm(1,5+^*)$
	6 kPa		650	$\pm(0,5+^*)$	$\pm(0,8+^*)$	$\pm(1,2+^*)$
	10 kPa		400	$\pm(0,4+^*)$	$\pm(0,6+^*)$	$\pm(1,0+^*)$
	16 kPa		250	$\pm(0,25+^*)$	$\pm(0,4+^*)$	$\pm(0,6+^*)$
ИК40	10 kPa	100 kPa	1000	$\pm(0,6+^*)$	$\pm(1,0+^*)$	$\pm(1,5+^*)$
	16 kPa		600	$\pm(0,5+^*)$	$\pm(0,8+^*)$	$\pm(1,2+^*)$
	25 kPa		400	$\pm(0,4+^*)$	$\pm(0,6+^*)$	$\pm(1,0+^*)$
	40 kPa		250	$\pm(0,25+^*)$	$\pm(0,4+^*)$	$\pm(0,6+^*)$
ИК100	25 kPa	400 kPa	1600	$\pm(0,6+^*)$	$\pm(1,0+^*)$	$\pm(1,5+^*)$
	40 kPa		1000	$\pm(0,5+^*)$	$\pm(0,8+^*)$	$\pm(1,2+^*)$
	60 kPa		650	$\pm(0,4+^*)$	$\pm(0,6+^*)$	$\pm(1,0+^*)$
	100 kPa		400	$\pm(0,25+^*)$	$\pm(0,4+^*)$	$\pm(0,6+^*)$
ИК250	60 kPa	500 kPa	800	$\pm(0,6+^*)$	$\pm(1,0+^*)$	$\pm(1,5+^*)$
	100 kPa		500	$\pm(0,5+^*)$	$\pm(0,8+^*)$	$\pm(1,2+^*)$
	160 kPa		300	$\pm(0,4+^*)$	$\pm(0,6+^*)$	$\pm(1,0+^*)$
	250 kPa		200	$\pm(0,25+^*)$	$\pm(0,4+^*)$	$\pm(0,6+^*)$
ИК600	160 kPa	1200 kPa	750	$\pm(0,6+^*)$	$\pm(1,0+^*)$	$\pm(1,5+^*)$
	250 kPa		450	$\pm(0,5+^*)$	$\pm(0,8+^*)$	$\pm(1,2+^*)$
	400 kPa		300	$\pm(0,4+^*)$	$\pm(0,6+^*)$	$\pm(1,0+^*)$
	600 kPa		200	$\pm(0,25+^*)$	$\pm(0,4+^*)$	$\pm(0,6+^*)$
ИК1,6М	0,4 MPa	5 MPa	1250	$\pm(0,6+^*)$	$\pm(1,0+^*)$	$\pm(1,5+^*)$
	0,6 MPa		800	$\pm(0,5+^*)$	$\pm(0,8+^*)$	$\pm(1,2+^*)$
	1,0 MPa		500	$\pm(0,4+^*)$	$\pm(0,6+^*)$	$\pm(1,0+^*)$
	1,6 MPa		300	$\pm(0,25+^*)$	$\pm(0,4+^*)$	$\pm(0,6+^*)$
ИК2,5М	0,6 MPa	5 MPa	800	$\pm(0,6+^*)$	$\pm(1,0+^*)$	$\pm(1,5+^*)$
	1,0 MPa		500	$\pm(0,5+^*)$	$\pm(0,8+^*)$	$\pm(1,2+^*)$
	1,6 MPa		300	$\pm(0,4+^*)$	$\pm(0,6+^*)$	$\pm(1,0+^*)$
	2,5 MPa		200	$\pm(0,25+^*)$	$\pm(0,4+^*)$	$\pm(0,6+^*)$
ИК6М	1,6 MPa	12 MPa	750	$\pm(0,6+^*)$	$\pm(1,0+^*)$	$\pm(1,5+^*)$
	2,5 MPa		450	$\pm(0,5+^*)$	$\pm(0,8+^*)$	$\pm(1,2+^*)$
	4,0 MPa		300	$\pm(0,4+^*)$	$\pm(0,6+^*)$	$\pm(1,0+^*)$
	6,0 MPa		200	$\pm(0,25+^*)$	$\pm(0,4+^*)$	$\pm(0,6+^*)$
ИК16М	4 MPa	50 MPa	1250	$\pm(0,6+^*)$	$\pm(1,0+^*)$	$\pm(1,5+^*)$
	6 MPa		800	$\pm(0,5+^*)$	$\pm(0,8+^*)$	$\pm(1,2+^*)$
	10 MPa		500	$\pm(0,4+^*)$	$\pm(0,6+^*)$	$\pm(1,0+^*)$
	16 MPa		300	$\pm(0,25+^*)$	$\pm(0,4+^*)$	$\pm(0,6+^*)$

Notes
 1 * One unit of the last digit, presented in percentage of the measurement range
 2 ** Reference designation of the precision grade.
 3 By demand of a customer it is possible to manufacture ЭКМ with different upper limits of measurements.

Table 2.9 – Electronic manometer ЭКМ-2005-ДИ, ЭКМ-2005А-ДИ

Reference Designation of a model	Row of upper limits Of measurement according to STATE STANDARDS	Maximal (test) pressure		Limits of tolerable basic reduced error γ , %, for precision grade		
		value	%	B**	C**	D**
ИМ16	4 kPa	40 kPa	1000	$\pm(0,6+^*)$	$\pm(1,0+^*)$	$\pm(1,5+^*)$
	6 kPa		650	$\pm(0,5+^*)$	$\pm(0,8+^*)$	$\pm(1,2+^*)$
	10 kPa		400	$\pm(0,4+^*)$	$\pm(0,6+^*)$	$\pm(1,0+^*)$
	16 kPa		250	$\pm(0,25+^*)$	$\pm(0,4+^*)$	$\pm(0,6+^*)$
ИМ40	10 kPa	200 kPa	2000	$\pm(0,6+^*)$	$\pm(1,0+^*)$	$\pm(1,5+^*)$
	16 kPa		1250	$\pm(0,5+^*)$	$\pm(0,8+^*)$	$\pm(1,2+^*)$
	25 kPa		800	$\pm(0,4+^*)$	$\pm(0,6+^*)$	$\pm(1,0+^*)$
	40 kPa		500	$\pm(0,25+^*)$	$\pm(0,4+^*)$	$\pm(0,6+^*)$
ИМ100	25 kPa	200 kPa	800	$\pm(0,6+^*)$	$\pm(1,0+^*)$	$\pm(1,5+^*)$
	40 kPa		500	$\pm(0,5+^*)$	$\pm(0,8+^*)$	$\pm(1,2+^*)$
	60 kPa		300	$\pm(0,4+^*)$	$\pm(0,6+^*)$	$\pm(1,0+^*)$
	100 kPa		200	$\pm(0,25+^*)$	$\pm(0,4+^*)$	$\pm(0,6+^*)$
ИМ250	60 kPa	500 kPa	800	$\pm(0,6+^*)$	$\pm(1,0+^*)$	$\pm(1,5+^*)$
	100 kPa		500	$\pm(0,5+^*)$	$\pm(0,8+^*)$	$\pm(1,2+^*)$
	160 kPa		300	$\pm(0,4+^*)$	$\pm(0,6+^*)$	$\pm(1,0+^*)$
	250 kPa		200	$\pm(0,25+^*)$	$\pm(0,4+^*)$	$\pm(0,6+^*)$
ИМ600	160 kPa	1200 kPa	750	$\pm(0,6+^*)$	$\pm(1,0+^*)$	$\pm(1,5+^*)$
	250 kPa		450	$\pm(0,5+^*)$	$\pm(0,8+^*)$	$\pm(1,2+^*)$
	400 kPa		300	$\pm(0,4+^*)$	$\pm(0,6+^*)$	$\pm(1,0+^*)$
	600 kPa		200	$\pm(0,25+^*)$	$\pm(0,4+^*)$	$\pm(0,6+^*)$
ИМ1,6М	0,4 MPa	5 MPa	1250	$\pm(0,6+^*)$	$\pm(1,0+^*)$	$\pm(1,5+^*)$
	0,6 MPa		800	$\pm(0,5+^*)$	$\pm(0,8+^*)$	$\pm(1,2+^*)$
	1,0 MPa		500	$\pm(0,4+^*)$	$\pm(0,6+^*)$	$\pm(1,0+^*)$
	1,6 MPa		300	$\pm(0,25+^*)$	$\pm(0,4+^*)$	$\pm(0,6+^*)$
ИМ2,5М	0,6 MPa	5 MPa	800	$\pm(0,6+^*)$	$\pm(1,0+^*)$	$\pm(1,5+^*)$
	1,0 MPa		500	$\pm(0,5+^*)$	$\pm(0,8+^*)$	$\pm(1,2+^*)$
	1,6 MPa		300	$\pm(0,4+^*)$	$\pm(0,6+^*)$	$\pm(1,0+^*)$
	2,5 MPa		200	$\pm(0,25+^*)$	$\pm(0,4+^*)$	$\pm(0,6+^*)$
ИМ6М	1,6 MPa	12 MPa	750	$\pm(0,6+^*)$	$\pm(1,0+^*)$	$\pm(1,5+^*)$
	2,5 MPa		450	$\pm(0,5+^*)$	$\pm(0,8+^*)$	$\pm(1,2+^*)$
	4,0 MPa		300	$\pm(0,4+^*)$	$\pm(0,6+^*)$	$\pm(1,0+^*)$
	6,0 MPa		200	$\pm(0,25+^*)$	$\pm(0,4+^*)$	$\pm(0,6+^*)$
ИМ16М	4 MPa	50 MPa	1250	$\pm(0,6+^*)$	$\pm(1,0+^*)$	$\pm(1,5+^*)$
	6 MPa		800	$\pm(0,5+^*)$	$\pm(0,8+^*)$	$\pm(1,2+^*)$
	10 MPa		500	$\pm(0,4+^*)$	$\pm(0,6+^*)$	$\pm(1,0+^*)$
	16 MPa		300	$\pm(0,25+^*)$	$\pm(0,4+^*)$	$\pm(0,6+^*)$
ИМ25М	6 MPa	50 MPa	800	$\pm(0,6+^*)$	$\pm(1,0+^*)$	$\pm(1,5+^*)$
	10 MPa		500	$\pm(0,5+^*)$	$\pm(0,8+^*)$	$\pm(1,2+^*)$
	16 MPa		300	$\pm(0,4+^*)$	$\pm(0,6+^*)$	$\pm(1,0+^*)$
	25 MPa		200	$\pm(0,25+^*)$	$\pm(0,4+^*)$	$\pm(0,6+^*)$
ИМ60М	16 MPa	90 MPa	550	$\pm(0,6+^*)$	$\pm(1,0+^*)$	$\pm(1,5+^*)$
	25 MPa		350	$\pm(0,5+^*)$	$\pm(0,8+^*)$	$\pm(1,2+^*)$
	40 MPa		200	$\pm(0,4+^*)$	$\pm(0,6+^*)$	$\pm(1,0+^*)$
	60 MPa		150	$\pm(0,25+^*)$	$\pm(0,4+^*)$	$\pm(0,6+^*)$

Notes

1 One unit of the last digit, presented in percentage of the measurement range

2 ** Reference designation of the precision grade.

Table 2.10 – Electronic manometers ЭКМ-2005-Д1В, ЭКМ-2005А-Д1В

Reference designation of a model	Row of upper limits of measurement according to STATE STANDARDS 22520-85		Maximal (test) pressure		Limits of tolerable basic reduced error γ , %, for precision grade		
	depression	excessive	value	%	depression	excessive	value
BK300	50 kPa	50 kPa	1200 kPa	2400	$\pm(0,6+^*)$	$\pm(1,0+^*)$	$\pm(1,5+^*)$
	100 kPa	60 kPa		2000	$\pm(0,5+^*)$	$\pm(0,8+^*)$	$\pm(1,2+^*)$
	100 kPa	150 kPa		800	$\pm(0,4+^*)$	$\pm(0,6+^*)$	$\pm(1,0+^*)$
	100 kPa	300 kPa		400	$\pm(0,25+^*)$	$\pm(0,4+^*)$	$\pm(0,6+^*)$
BK500	100 kPa	60 kPa	1200 kPa	2000	$\pm(0,6+^*)$	$\pm(1,0+^*)$	$\pm(1,5+^*)$
	100 kPa	150 kPa		800	$\pm(0,5+^*)$	$\pm(0,8+^*)$	$\pm(1,2+^*)$
	100 kPa	300 kPa		400	$\pm(0,4+^*)$	$\pm(0,6+^*)$	$\pm(1,0+^*)$
	100 kPa	500 kPa		250	$\pm(0,25+^*)$	$\pm(0,4+^*)$	$\pm(0,6+^*)$
BK1,5M	0,1 MPa	0,3 MPa	5 MPa	1500	$\pm(0,6+^*)$	$\pm(1,0+^*)$	$\pm(1,5+^*)$
	0,1 MPa	0,5 MPa		1000	$\pm(0,5+^*)$	$\pm(0,8+^*)$	$\pm(1,2+^*)$
	0,1 MPa	0,9 MPa		550	$\pm(0,4+^*)$	$\pm(0,6+^*)$	$\pm(1,0+^*)$
	0,1 MPa	1,5 MPa		300	$\pm(0,25+^*)$	$\pm(0,4+^*)$	$\pm(0,6+^*)$
BK2,4M	0,1 MPa	0,5 MPa	5 MPa	1000	$\pm(0,6+^*)$	$\pm(1,0+^*)$	$\pm(1,5+^*)$
	0,1 MPa	0,9 MPa		550	$\pm(0,5+^*)$	$\pm(0,8+^*)$	$\pm(1,2+^*)$
	0,1 MPa	1,5 MPa		300	$\pm(0,4+^*)$	$\pm(0,6+^*)$	$\pm(1,0+^*)$
	0,1 MPa	2,4 MPa		200	$\pm(0,25+^*)$	$\pm(0,4+^*)$	$\pm(0,6+^*)$
<p>Notes</p> <p>1 * One unit of the last digit, presented in percentage from the measuring range.</p> <p>2 ** Reference designation of the precision grade.</p> <p>3 By demand of a consumer it is possible to manufacture ЭКМ with different upper measurement limits.</p>							

Table 2.11 – Electronic manometers ЭКМ-2005-Д/В, ЭКМ-2005А-Д/В

Reference designation of a model	Row of upper limits of measurement according to STATE STANDARDS 22520-85		Maximal (test) pressure		Limits of tolerable basic reduced error γ , %, for precision grade		
	depression	excessive	value	%	B**	C**	D**
BM150	30 kPa	30 kPa	500 kPa	1650	$\pm(0,6+^*)$	$\pm(1,0+^*)$	$\pm(1,5+^*)$
	50 kPa	50 kPa		1000	$\pm(0,5+^*)$	$\pm(0,8+^*)$	$\pm(1,2+^*)$
	100 kPa	60 kPa		800	$\pm(0,4+^*)$	$\pm(0,6+^*)$	$\pm(1,0+^*)$
	100 kPa	150 kPa		300	$\pm(0,25+^*)$	$\pm(0,4+^*)$	$\pm(0,6+^*)$
BM300	50 kPa	50 kPa	1200 kPa	2400	$\pm(0,6+^*)$	$\pm(1,0+^*)$	$\pm(1,5+^*)$
	100 kPa	60 kPa		2000	$\pm(0,5+^*)$	$\pm(0,8+^*)$	$\pm(1,2+^*)$
	100 kPa	150 kPa		800	$\pm(0,4+^*)$	$\pm(0,6+^*)$	$\pm(1,0+^*)$
	100 kPa	300 kPa		400	$\pm(0,25+^*)$	$\pm(0,4+^*)$	$\pm(0,6+^*)$
BM500	100 kPa	60 kPa	1200 kPa	2000	$\pm(0,6+^*)$	$\pm(1,0+^*)$	$\pm(1,5+^*)$
	100 kPa	150 kPa		800	$\pm(0,5+^*)$	$\pm(0,8+^*)$	$\pm(1,2+^*)$
	100 kPa	300 kPa		400	$\pm(0,4+^*)$	$\pm(0,6+^*)$	$\pm(1,0+^*)$
	100 kPa	500 kPa		250	$\pm(0,25+^*)$	$\pm(0,4+^*)$	$\pm(0,6+^*)$
BM1,5M	0,1 MPa	0,3 MPa	5 MPa	1650	$\pm(0,6+^*)$	$\pm(1,0+^*)$	$\pm(1,5+^*)$
	0,1 MPa	0,5 MPa		1000	$\pm(0,5+^*)$	$\pm(0,8+^*)$	$\pm(1,2+^*)$
	0,1 MPa	0,9 MPa		550	$\pm(0,4+^*)$	$\pm(0,6+^*)$	$\pm(1,0+^*)$
	0,1 MPa	1,5 MPa		300	$\pm(0,25+^*)$	$\pm(0,4+^*)$	$\pm(0,6+^*)$
BM2,4M	0,1 MPa	0,5 MPa	5 MPa	1000	$\pm(0,6+^*)$	$\pm(1,0+^*)$	$\pm(1,5+^*)$
	0,1 MPa	0,9 MPa		550	$\pm(0,5+^*)$	$\pm(0,8+^*)$	$\pm(1,2+^*)$
	0,1 MPa	1,5 MPa		300	$\pm(0,4+^*)$	$\pm(0,6+^*)$	$\pm(1,0+^*)$
	0,1 MPa	2,4 MPa		200	$\pm(0,25+^*)$	$\pm(0,4+^*)$	$\pm(0,6+^*)$
<p>Notes 1 * One unit of the last digit, presented in percentage from the measuring range. 2 ** Reference designation of the precision grade. 3 By demand of a consumer it is possible to manufacture ЭКМ with different upper measurement limits..</p>							

Table 2.12 – Electronic manometers ЭКМ 2005-ДД, ЭКМ-2005А-ДД

Reference designation of a model	Row of upper limits of measurement according to STATE STANDARDS 22520-85	Tolerable operational excessive pressure, MPa	Limits of tolerable basic reduced error γ , %, for index order		
			B**	C**	D**
ДМ40	10 kPa	16	$\pm(0,6+^*)$	$\pm(1,0+^*)$	$\pm(1,5+^*)$
	16 kPa		$\pm(0,5+^*)$	$\pm(0,8+^*)$	$\pm(1,2+^*)$
	25 kPa		$\pm(0,4+^*)$	$\pm(0,6+^*)$	$\pm(1,0+^*)$
	40 kPa		$\pm(0,25+^*)$	$\pm(0,4+^*)$	$\pm(0,6+^*)$
ДМ100	25 kPa	16	$\pm(0,6+^*)$	$\pm(1,0+^*)$	$\pm(1,5+^*)$
	40 kPa		$\pm(0,5+^*)$	$\pm(0,8+^*)$	$\pm(1,2+^*)$
	63 kPa		$\pm(0,4+^*)$	$\pm(0,6+^*)$	$\pm(1,0+^*)$
	100 kPa		$\pm(0,25+^*)$	$\pm(0,4+^*)$	$\pm(0,6+^*)$
ДМ250	63 kPa	16	$\pm(0,6+^*)$	$\pm(1,0+^*)$	$\pm(1,5+^*)$
	100 kPa		$\pm(0,5+^*)$	$\pm(0,8+^*)$	$\pm(1,2+^*)$
	160 kPa		$\pm(0,4+^*)$	$\pm(0,6+^*)$	$\pm(1,0+^*)$
	250 kPa		$\pm(0,25+^*)$	$\pm(0,4+^*)$	$\pm(0,6+^*)$
ДМ630	160 kPa	16	$\pm(0,6+^*)$	$\pm(1,0+^*)$	$\pm(1,5+^*)$
	250 kPa		$\pm(0,5+^*)$	$\pm(0,8+^*)$	$\pm(1,2+^*)$
	400 kPa		$\pm(0,4+^*)$	$\pm(0,6+^*)$	$\pm(1,0+^*)$
	630 kPa		$\pm(0,25+^*)$	$\pm(0,4+^*)$	$\pm(0,6+^*)$
ДМ2,5М	0,6 MPa	16	$\pm(0,6+^*)$	$\pm(1,0+^*)$	$\pm(1,5+^*)$
	1,0 MPa		$\pm(0,5+^*)$	$\pm(0,8+^*)$	$\pm(1,2+^*)$
	1,6 MPa		$\pm(0,4+^*)$	$\pm(0,6+^*)$	$\pm(1,0+^*)$
	2,5 MPa		$\pm(0,25+^*)$	$\pm(0,4+^*)$	$\pm(0,6+^*)$
Notes					
1 * One unit of the last digit, presented in percentage from the measuring range.					
2 ** Reference designation of the precision grade.					
3 By demand of a consumer it is possible to manufacture ЭКМ with different upper measurement limits.					

2.2.2 Sub-range of measurements of ЭКМ is selected at configuration of the instrument and it should not exceed the range of measurements for the present model (parameters «IdPH» и «IdPL» see the table 2.21).

Nominal static characteristic of ЭКМ with linear dependence corresponds to the following type

$$A=P, \quad (2.1)$$

where A – current value of indicator reading, corresponding to measured pressure ;

P – value of measured pressure in preset units of measurement.

2.2.3 Nominal static characteristic of ЭКМ with a root extracting dependence correspond to the following form

$$A = \sqrt{\frac{P - A_H}{A_B - A_H}} \cdot 100\% , \quad (2.2)$$

where A_B и A_H – upper and lower limits of selected sub-range of measurements (parameters «OdPH» and «OdPL» see table 2.21).

2.2.4 Range of unified input signal – 0...5, 0...20, 4...20 mA is selected at configuration of the instrument.

The limit of the tolerable basic error of current output is determined from the formula

$$\gamma_l = 0,1 + \gamma , \quad (2.3)$$

where γ_l – limit of tolerable basic reduced error of current output;

γ – limits of tolerable basic reduced, presented in tables 2.6 – 2.12.

2.2.5 Nominal static characteristic of ЭКМ with current output correspond to the following form

$$I = \frac{P - A_H}{A_B - A_H} \cdot (I_B - I_H) + I_H , \quad (2.4)$$

where I – current value of output current signal, corresponding to measured pressure, mA;

I_B and I_H – upper and lower limiting values of output current signal.

2.2.6 Nominal static characteristic of ЭКМ with root extracting dependence from current output correspond to the following form

$$I = \sqrt{\frac{P - A_H}{A_B - A_H}} \cdot (I_B - I_H) + I_H . \quad (2.5)$$

2.2.7 Variation of the output signal does not exceed 0,5 of the limit of tolerable basic error.

2.2.8 ЭКМ is stable to impact of sinusoidal vibrations of high frequency (with crossover frequency from 57 to 62 Hz) with the following parameters:

- frequency – (5...80) Hz;
- amplitude of shift for the frequency is lower then crossover frequency – 0,15 mm;
- acceleration amplitude for the frequency is higher then crossover frequency – 19,6 m/s².

The limit of the tolerable auxiliary error for ЭКМ during impact of vibration does not exceed the limit of the tolerable basic error.

2.2.9 Modification of value of output signal of ЭКМ-2005-ДД, ЭКМ-2005А-ДД, caused by variation of operational excessive pressure within the range from zero to maximum permitted and from maximum permitted to zero (see table 2.12), presented in percentage from the range of measurement of output signal does not exceed values of γ_p , determined from the formula

$$\gamma_p = K_p \Delta P_{\text{раб}} \cdot \frac{P_{B\text{MAX}}}{P_B}, \quad (2.6)$$

where $\Delta P_{\text{раб}}$ – variation of operational excessive pressure, MPa;
 $P_{B\text{MAX}}, P_B$ – maximum upper limit of measurements and upper limit of measurement accordingly for the present version of the converter, MPa;
 K_p – coefficient from the table 2.13.

Table 2.13 – Coefficients K_p for ЭКМ 2005-ДД, ЭКМ 2005А-ДД

Model reference designation	$K_p, \%/MPa$
ДМ2,5 М	0,05
ДМ630	0,05
ДМ250	0,15
ДМ100	0,15
ДМ40	0,3

2.2.10 Modification of output signal of ЭКМ-2005-ДА, ЭКМ-2005А-ДА (absolute pressure), caused by variation of atmospheric pressure for ± 10 kPa (75 mm merc.column.) from the steady-state value within the range from 84 to 106,7 kPa (from 630 to 800 mm merc. column), does not exceed 0,2 of the limit of the basic error.

2.2.11 Auxiliary error of ЭКМ, is caused by temperature variation of ambient air from normal $(23 \pm 2) ^\circ\text{C}$ to any temperature within the range of operational temperatures for every $10 ^\circ\text{C}$ of temperature change (γ_T , in %), does not exceed values, presented in the table 2.14.

Table 2.14 – Limits of the tolerable auxiliary error from an impact of ambient temperature air

Upper limit (range) in % from maximal	γ_T , %/10 °C, for accuracy rating			Range of temperature ambient air	Code of climatic version
	B	C	D		
100	±0,20	±0,25	±0,25	from plus 5 to plus 50 °C	t0550
60	±0,25	±0,30	±0,30		
40	±0,30	±0,35	±0,35		
25	±0,35	±0,40	±0,40		
100	±0,20	±0,25	±0,25	from minus 25 to plus 70 °C	t2570
60	±0,25	±0,30	±0,30		
40	±0,30	±0,35	±0,35		
25	±0,35	±0,40	±0,40		
100	±0,25*	±0,30	±0,30	from minus 40 to plus 70 °C (with exception of subrange from minus 25 to plus 70 °C)	t4070
60	±0,30*	±0,40	±0,40		
40	±0,35*	±0,45	±0,45		
25	±0,40*	±0,50	±0,50		
Notes — * By special order from minus 40 to plus 25 °C					

2.2.12 Auxiliary error of ЭKM, is caused by an impact of increased humidity and does not exceed 0,2 of the limit of tolerable basic error.

2.2.13 Auxiliary error of ЭKM, is caused by an impact of constant magnetic fields and (or) variable fields of mains (commercial) frequency with voltage up to 600 A/m, does not exceed 0,2 of the limit of tolerable basic error

2.2.14 Range of measurements of ЭKM with square rooting function lies within the limits 6,25...100 % from the range of measured pressure.

2.2.15 Area of settings assignment corresponds to the range of measure value.

2.2.16 Hysteresis of settings actuation is asymmetrical, is programmable independently for every setting and is regulated within the limits of the whole range of measured value.

2.2.17 The limit of tolerable basic error of signaling operation does not exceed the limit of the basic error of measured pressure readings.

2.2.18 The limit of tolerable basic error of signaling operation, caused by temperature variation of ambient air from normal to any temperature within the range of operating temperatures for every 10 °C of temperature variation, does not exceed the values presented in the table 2.14.

2.2.19 The limit of tolerable auxiliary error of signaling operation, caused by variation of power supply voltage from nominal to any within the range of usability conditions, does not exceed 0,2 of the limit of tolerable basic error of signaling operation.

2.2.20 Power supply of ЭКМ is effected from:

- alternative current network of sinusoidal form with frequency from 40 to 100 Hz and voltage from 110 to 249 V with nominal values - frequency 50 Hz and voltage 220 V and from the network of direct current within the range from 150 to 249 V with nominal value of voltage of 220 V (code when ordering – 220);
- alternative current network of sinusoidal form with frequency from 40 to 100 Hz and voltage from 110 to 249 V with nominal values - frequency 50 Hz and voltage 220 V and from the network of direct current within the range from 150 to 249 V with nominal value of voltage of 220 V with galvanic isolated circuits of power supply and commutation (current output is absent) [code when ordering – 220Г];
- direct current networks with voltage from 18 to 40 V with nominal value of voltage of $(24 \pm 0,48)$ V or $(36 \pm 0,72)$ V (code when ordering – 24);
- direct current networks with voltage from 18 to 40 V with nominal value of voltage of $(24 \pm 0,48)$ V or $(36 \pm 0,72)$ V with galvanic isolated circuits of power supply and commutation (current output is absent) [code when ordering - 24Г];
- incorporated batteries with voltage of 12 V in case of voltage absence in the network (code when ordering – Б).

2.2.21 Power consumed by ЭКМ-2005, ЭКМ-2005А, does not exceed 5 Wt.

2.2.22 The limit of the tolerable auxiliary error caused by variation of power supply voltage from nominal to minimal and maximal, presented in the item 2.2.20, does not exceed 0,2 of the limit of tolerable basic error.

2.2.23 Load resistances for current output should not exceed:

- 2 kOhm – for output signal 0...5 mA;
- 0,4 kOhm – for output signal 0...20, 4...20 mA.

2.2.24 After connection of external load to resistance not exceeding values presented in item 2.2.23, the basic error of ЭКМ and variation of the output signal corresponds to и вариация выходного сигнала соответствуют п. 2.2.1, п. 2.2.4 и п. 2.2.7.

2.2.25 Time of setting of output signal of ЭКМ at stepwise pressure variation equal to 90 % of measuring range, not more than 0,1 s, at determined value of damping time, equal to 0. The criteria of setting of signal time is reaching the difference between current and measured pressure value, not exceeding 5 % of the measurement range.

2.2.26 ЭКМ-2005-ДА, ЭКМ-2005-ДИ, ЭКМ-2005-ДИВ possess durability and impermeability at testing pressures, presented in tables 2.6 - 2.11.

ЭКМ-2005-ДА, ЭКМ-2005-ДИ, ЭКМ-2005-ДИВ endure impact of overloads corresponding to testing pressure during 15 minutes.

After 15 minutes after termination of such an impact ЭКМ-2005-ДА, ЭКМ-2005-ДИ, ЭКМ-2005-ДИВ correspond to item 2.2.1, 2.2.4 and item 2.2.7.

2.2.26.1 ЭКМ-2005-ДД withstands durability testing by test pressure according to STATE STANDARDS 356-80 and for impermeability by maximum permissible excessive pressure, presented in the table 2.12, meanwhile for conditional pressure P_y according to STATE STANDARDS 356-80 is accepted the maximum permissible operational excessive pressure.

2.2.26.2 ЭКМ-2005-ДД withstands overload from the plus and minus chambers by one-sided pressure, the values of which are presented in the table 2.15.

Table 2.15 – The values of maximal one-sided pressure for ЭКМ-2005-ДД

Reference designation of the model	Maximal one-sided pressure
ДМ40	200 kPa
ДМ100	400 kPa
ДМ250	800 kPa
ДМ630	2 MPa
ДМ2,5М	8 Mpa

After 12 hours after impact of overload the converters ЭКМ-2005-ДД correspond to item 2.2.1, 2.2.4 and item 2.2.7.

2.2.27 Electrical resistance of insulation of power supply circuits of 24 V and current output of ЭКМ relative to the housing and between themselves during testing voltage of 100 V not less than:

- 20 MOhm at the temperature of ambient air (20 ± 5) °C and relative humidity from 30 to 80 %;
- 5 MOhm at the upper value of temperature of operational conditions and relative humidity from 30 to 80 %;
- 1 MOhm at the upper value of relative humidity of operational conditions and the temperature of ambient air (35 ± 3) °C.

2.2.27.1 Electrical resistance of insulation of power supply circuits of 220 V and signaling of ЭКМ relative to the housing and the circuit of current output at testing voltage of 500 V not less than:

- 20 MOhm at the temperature of ambient air (20 ± 5) °C and relative humidity from 30 to 80 %;

- 5 MOhm at the higher value of the temperature of operational conditions and relative humidity from 30 to 80 %;
- 1 MOhm at the upper vale of relative humidity and operational conditions and temperature of ambient air (35±3) °C.

2.2.28 Insulation of electrical circuits of power supply of 220 V and signaling relative to the housing and current output depending on conditions of testing withstands during 1 minute an impact of testing voltage of practically sinusoidal form with frequency from 45 to 65 Hz:

- 1500 V at the temperature of ambient air (20±5) °C and relative humidity from 30 to 80 %;
- 900 V at the relative humidity (95±3) % and temperature of ambient air (35±3) °C.

2.2.28.1 Insulation of electrical circuits of current output relative to the housing depending on conditions of testing withstands during 1 minute an impact of testing voltage of practically sinusoidal form with frequency from 45 to 65 Hz:

- 500 V at the temperature of ambient air (20±5) °C and relative humidity from 30 to 80 %;
- 300 V at the relative humidity (95±3) % and temperature of ambient air (35±3) °C.

2.2.28.2 Insulation of electrical circuits of power supply 24 V (36 V) and current output of ЭKM relative to the housing and between themselves withstands during 1 minute an impact of testing voltage:

- 500 V at the temperature of ambient air (20±5) °C and relative humidity from 30 to 80 %;
- 300 V at the relative humidity (95±3) % and temperature of ambient air (35±3) °C.

2.2.29 Components of ЭKM, contacting with measured media, are made of corrosion-proof material and correspond to presented in tables 2.16, 2.17, 2.18, 2.19.

Table 2.16 – Code of connection to the process of (connecting pipe thread), besides ЭKM-2005-ДД

Connecting pipe thread (see. picture 2.2)	Code when ordering	Execution code
M39x1,5 «open membrane» (ceramic)	M39	13x; P≤40 kPa
M24x1,5 «open membrane» (ceramic)	M24	13x; P≥40 kPa
M20x1,5 «open membrane» (metallic)	M20	12; P≥100 kPa
M20x1,5	M20	12x, 13x; 16 кПа≤P≤60 МПа
G1/2"	G2	12x, 13x; 16 кПа≤P≤60 МПа
XX	Connecting sizes of the connecting pipe according to the customer's draft	

Note — * Only for general industrial execution.

ЭKM with «open membrane» are used for measuring of pressure of viscous medium. When ordering ЭKM-2005-ДД the code of connection to the process «M20» should be indicated.

Table 2.17 – Version of the models ЭKM as materials are concerned

Code of the version	Version as materials are concerned		
	membranes	connecting pipes	Sealing rings (x)
12x	Stainless steel 316L	12X18H10T	x=V, E, P
12	Stainless steel 316L	12X18H10T	Without sealing rings
13x	Al ₂ O ₃	12X18H10T	x=V, E, P

Table 2.18– Sealing rings

Material	Application	Symbols in version code
Viton (FKM)	Oil products, Acids	V
Buna (EPDM)	Ammonia	E
Teflon (PTFE)	All Media	P

Table 2.19 – Version as to materials for different models

Models	Version code	Basic version
AMxxx, ИМxxx, ВМxxx	12x	12V
AMxxx, ИМxxx, ВМxxx	12	12
AKxxx, Икxxx, ВКxxx	13x	13V
ДМxxx	12V, 12E	12V

2.2.30 Temperature of measured media in the operating chamber of ЭКМ from minus 40 to plus 120 °C.

2.2.31 Overall dimensions, connecting and mounting dimensions of ЭКМ correspond to the ones presented at the pictures 2.1 – 2.3.

2.2.32 Mass of ЭКМ:

– Not more than 1,0 kg for the version ЭКМ-2005-ДА, ЭКМ-2005-ДИ, ЭКМ-2005-ДИВ;

– Not more than 1,3 kg for the version of ЭКМ-2005-ДД.

2.2.33 ЭКМ is stable to impact of ambient temperature impact in accordance with item 2.1.9.

2.2.34 ЭКМ is stable to impact of humidity:

– up to 100 % at the temperature of 30 °C and lower temperatures, with condensation of humidity for the climatic version C2 according to STATE STANDARDS 12997-84 and STATE STANDARDS 15150-69;

– up to 95 % at the temperature of 35 °C and lower temperatures, without condensation of humidity for the climatic version C3 according to STATE STANDARDS 12997-84 and STATE STANDARDS 15150-69.

2.2.35 ЭКМ in transport tare withstand temperature up to 60 °C.

2.2.36 ЭКМ in transport tare withstand temperature up to minus 50 °C.

2.2.37 ЭКМ in transport tare are stable to impact of ambient air medium with relative humidity 98 % at the temperature of 35 °C.

2.2.38 ЭКМ is durable to impact of bumping shocks with the number of shocks per minute equal to 80, medium quadratic value of acceleration of 98 m/s² and exposure time of 1 hour.

2.2.39 ЭКМ is resilient and durable to impact of sinusoidal vibration within the range from 1 to 100 Hz At the amplitude of vibration acceleration of 20 m/s².

2.2.39.1 ЭКМ-2005A is stable and durable to impact of sinusoidal vibration within the range from 1 to 120 Hz at the amplitude of vibration acceleration 20 m/s² and corresponds to the group of vibration impact stability 2 or 1 (correspondingly) by СТО.1.1.1.07.001.0675-2008.

Auxiliary error, caused by an impact of vibration within the whole range of frequencies, presented in percentage from the range of measurement of output signal, does not exceed:

– (+1,5 %) for the range of measurement less than 2,5 kPa (250 kgs/m²);

– (+0,6 %) for the range of measurement 2,5 kPa (250 kgs/m²) and more.

Amplitude of output signal pulse, having frequency within the limits of the bandwidth of ЭКМ-2005А, does not exceed 0,6 % of the range of measurement of output signal.

2.2.40 ЭКМ does not have constructive elements and units with resonance frequencies from 5 to 25 Hz.

2.2.41 ЭКМ is stable and resilient to impact of mechanical shocks of singular nature with a peak shock acceleration of 20 m/s², with the duration of shock pulse from 2 to 20 ms and general number 30.

2.2.42 ЭКМ is stable and resilient to impact of mechanical shocks of multiple action with a peak shock acceleration of 30 m/s², with preferable durability of action of impact of 10 ms (permissible duration - from 2 to 20 ms) and number of shocks in every direction - 20.

2.2.43 ЭКМ is stable for earthquake load, equivalent to impact of vibration with parameters, presented in the table 2.20.

Table 2.20 – Parameters of earthquake load

Frequency, Hz	1,0	2,0	3,0	4,0	5,0	6,0	8,0	10,0	15,0	20,0	30,0
Acceleration, m/s ²	6,0	15,0	29,0	51,0	48,0	43,0	38,0	31,0	20,0	19,0	14,0

2.2.43.1 Variation of the output signal of ЭКМ-2005А, caused by earthquake load, is presented in percentage from the range of variation of input signal, does not exceed values γ_c , determined from the formula

$$\gamma_c = K_c \cdot \Delta P_{\text{раб}} \cdot \frac{P_{B\text{MAX}}}{P_B}, \quad (2.7)$$

where $P_{B\text{MAX}}$, P_B - are the same as in the formula (2.6);

K_c - coefficient, which values are presented in the table 2.20.1.

Table 2.20.1

Direction of vibration	Value K_c в зависимости от верхнего предела измерений, %			
	less 2,5 kPa	from 2,5 to 10 kPa	from 10 to 250 kPa	from 0,4 to 100 mPA
Vertical	3,00	1,00	0,50	0,25
Horizontal	10,00	5,00	3,00	0,25

2.2.43.2 ЭКМ-2005А should withstand impact of variable pressure, changing from 20-30 to 70-80 % of the upper limit of measurement, with the following number of cycles:

- 20000 – for upper limit of measurement up to 25 MPa;
- 15000 – for upper limit of measurement 40, 60 MPa.

After impact of live pressure converters should correspond to item 2.2.1 and item 2.2.4.

2.2.43.3 ЭКМ-2005А, supplied to the objects of nuclear power stations (UAE) should withstand an impact of a falling plane (YC) and an air blast (BYB) in accordance with the table 2.20.2

Table 2.20.2

Frequency, Hz	Acceleration m/s ² at a relative damping, %							
	1		2		5		10	
	YC	BYB	YC	BYB	YC	BYB	YC	BYB
0	0	0	0	0	0	0	0	0
10	0	140	23	110	20	70	16	60
30	24	140	23	110	20	70	16	60
50	25	120	23	90	22	70	18	6
100	25	90	23	85	22	55	18	50
150	15	40	15	40	15	40	15	40
200	15	25	15	25	15	25	15	25
300	10		10		10		10	
400	10		10		10		10	

Note — In the table 2.20.2 are presented generalized spectrum of answers on the construction structures for an impact of YC and BYB depending on decrement of oscillations.

2.2.44 Provision of electromagnetic compatibility and noise immunity.

2.2.44.1 ЭКМ by stability to electromagnetic interference belongs to the execution group IV, criteria of operational quality A according to STATE STANDARDS P 50746-2000.

2.2.44.2 ЭКМ normally functions and does not create any interferences in conditions of joint operation with equipment of systems and elements for which they are designed as well as with equipment of different designation which may be used together with present converters in a typical interference situation.

2.2.45 The housing of ЭКМ provide:

- Required stability to decontaminating agents: rectified ethyl technical alcohol according to STATE STANDARDS 18300-72 and (or) 5 % solution of citric acid in C₂H₅OH (density 96 %) plus triple washing by synthetic detergents according to STATE STANDARDS 29075-91;
- Reliable working of ЭКМ during operation and compliance with requirements of conservation during storage and transportation .

2.2.45.1 ЭKM-2005A permits decontamination of external surfaces (it is guaranteed by selected materials) when decontaminating premises by decontaminating solutions:

- first solutions - caustic soda (NaOH) - 50-60 gr/l, potassium permanganate (KMnO_4) - 5-10 gr/l;
- second solution – oxalic acid ($\text{H}_2\text{C}_2\text{O}_4$) - 20-40 gr/l.

Removal of dust and moisture from surface is performed without any problem.

Technical requirements to technology of application of lacquer coating correspond to OCT 107.9.4003-96.

Evaluation of correspondence of ЭKM to requirements of quality of surfaces according to STATE STANDARDS 25804.8-83.

2.2.46 ЭKM-2005A is stable to impact of absorbed dose power for groups of location groups 1.3, 1.4, 2.1-2.3 in accordance with the table A.1 of appendix A CTO 1.1.1.07.001.0675-2008.

2.2.47 Reliability index

2.2.47.1 Average error-free running time not less than:

- 150000 hours for ЭKM-2005;
- 250000 hours for ЭKM-2005A.

2.2.47.2 Possibility of no-failure operation during 8000 hours in conditions of operation of NPP not less than 0,97 for ЭKM-2005A.

2.2.47.3 Average time of rehabilitation does not exceed 1 hour.

2.2.47.4 Average life time of ЭKM is not less than 12 years.

2.2.47.5 Average life time of ЭKM-2005A is not less than 15 years.

2.3 DESIGN AND OPERATION

2.3.1. General view of ЭКМ

At the pictures 2.1, 2.2, 2.4 are presented by diagrams of general view of electronic manometers ЭКМ.

General view of ЭКМ-2005-ДА, ЭКМ-2005-ДИ, ЭКМ-2005-ДИВ

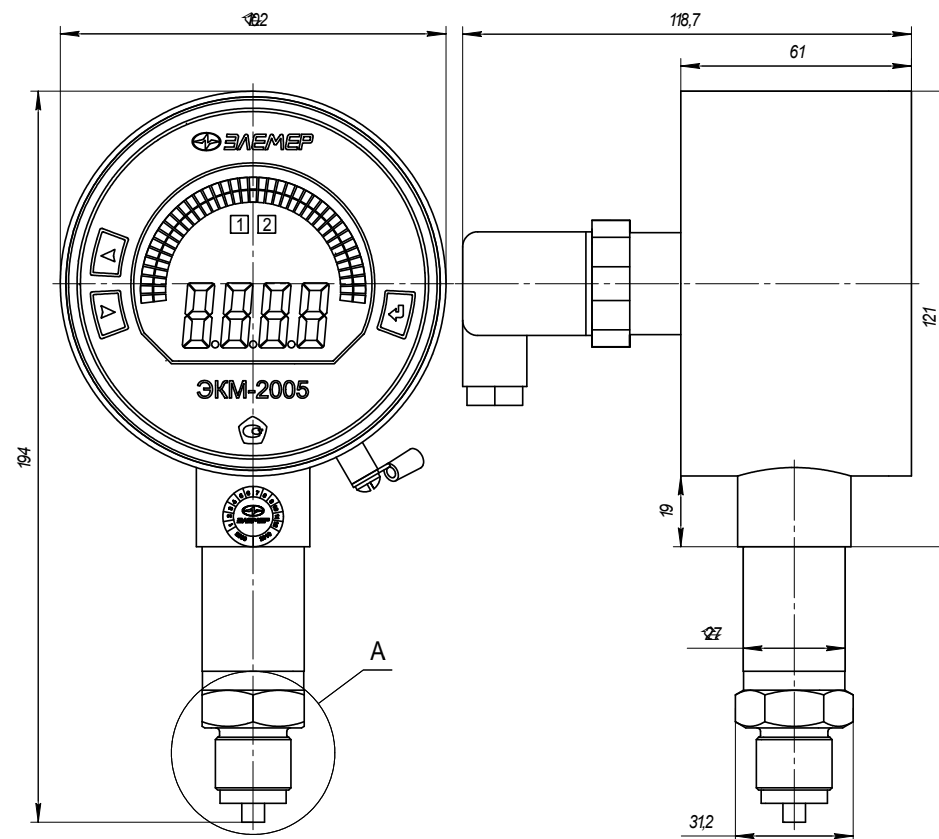

Picture 2.1

General view ЭКМ-2005-ДД

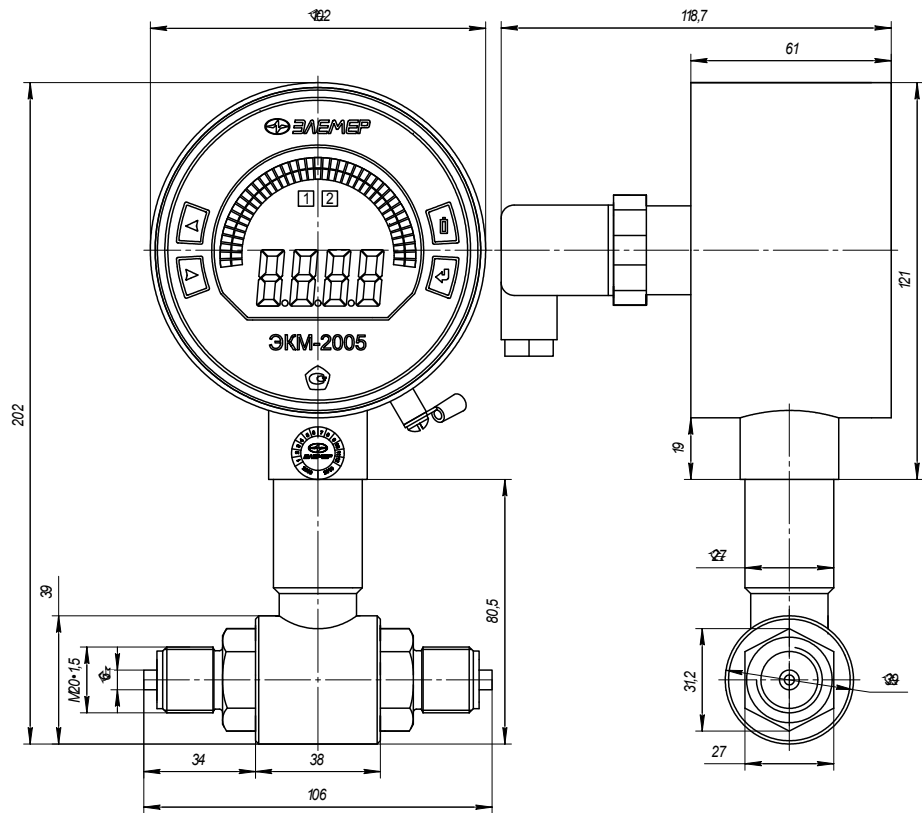

Picture 2.2

Connection types to the process (Place A– connection pipe zone)

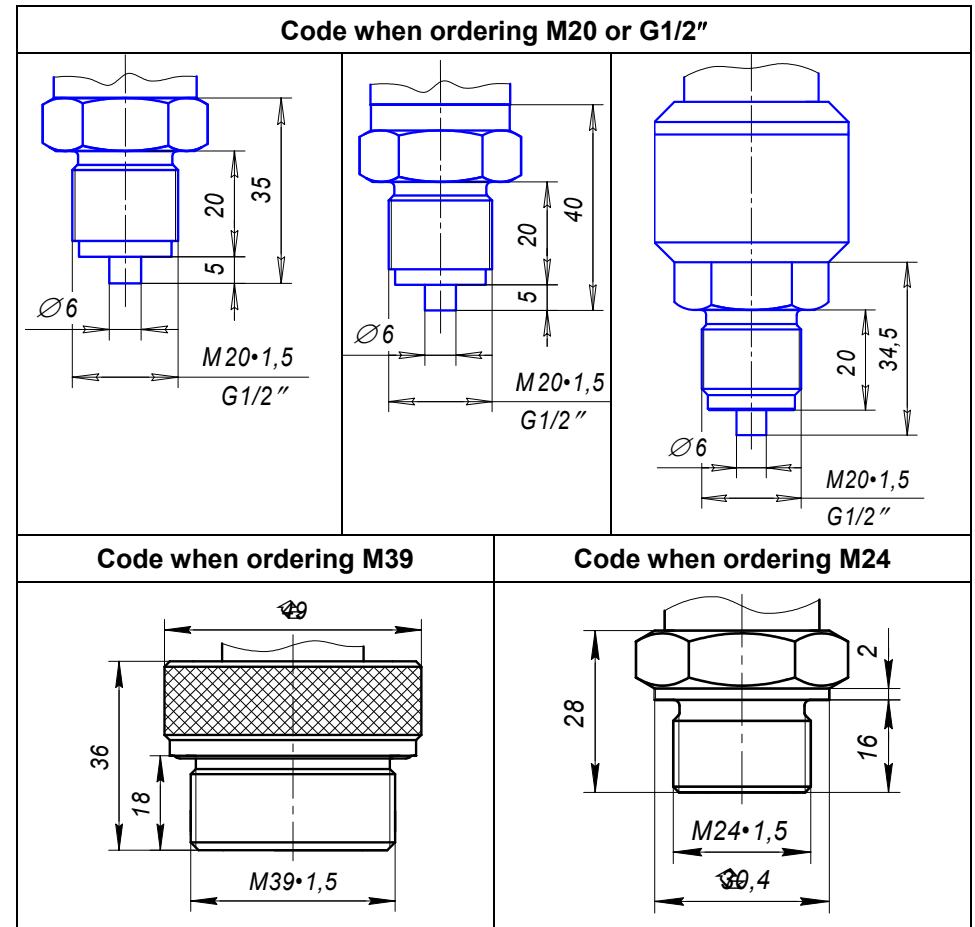

Picture 2.3

**Basic version
with connector GSP-311**

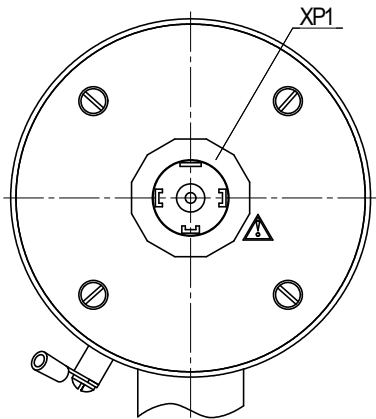

**Version with current output and without current
output with galvanic isolated circuits of power
supply and commutation
with connectors GSP-311 and GSSNA 300**

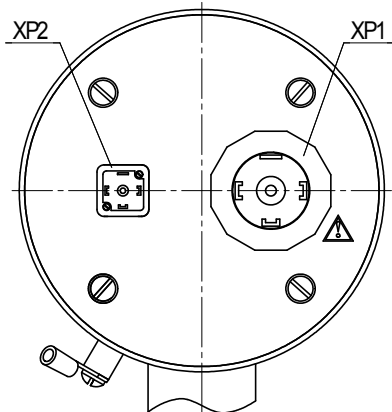

**Basic version
with connector 2PMГ-22**

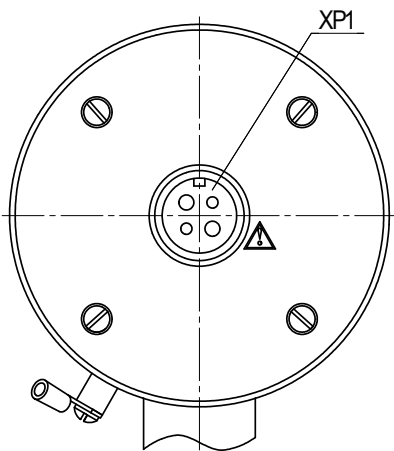

**Version with current output and without current
output with galvanic isolated circuits of power
supply and commutation
with connectors 2PMГ-22 and 2PMГ-14**

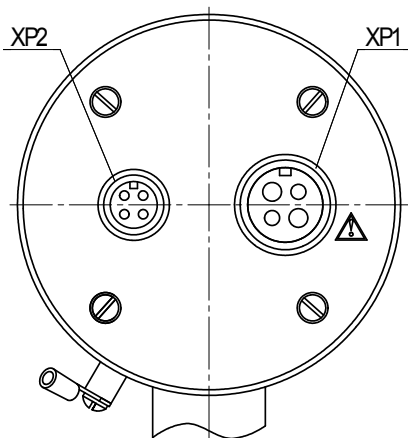





Picture 2.4

2.3.2 ЭКМ consists of sensor module, power supply module and a relay, system module, managing channels of signaling, LCD-display, module of current output and a keyboard. Measured medium is supplied to the primary converted chamber, under an impact of pressure deformation of measuring membrane takes place, that results in variation of electrical resistance of resistive-strain sensors located on it, as a result of what the primary converter produces voltage. The system module measures voltage signal received from sensor module, and calculates current value of measure pressure, displays information on LCD – indicator, governs signaling channels, module of current output and performs keyboard enquiry. Power supply module and relay provide power supply of all units of ЭКМ and perform commutation of signaling circuits. Module of current output forms unified current output – 0...5 mA, 0...20 mA or 4...20 mA, type of current output is set when configuring ЭКМ by customer. There is no need for additional power supply for operation of current output in ЭКМ. When connecting ЭКМ to power supply of direct current polarity of connection has no difference.

2.3.3 On the front panel of ЭКМ there are situated (see picture 2.5):

– combined LCD - display;

– keys «», «», «» for operation with menu of the instrument;

– key «» for short time (up to 30 s) including indication of ЭКМ in case of power voltage absence.



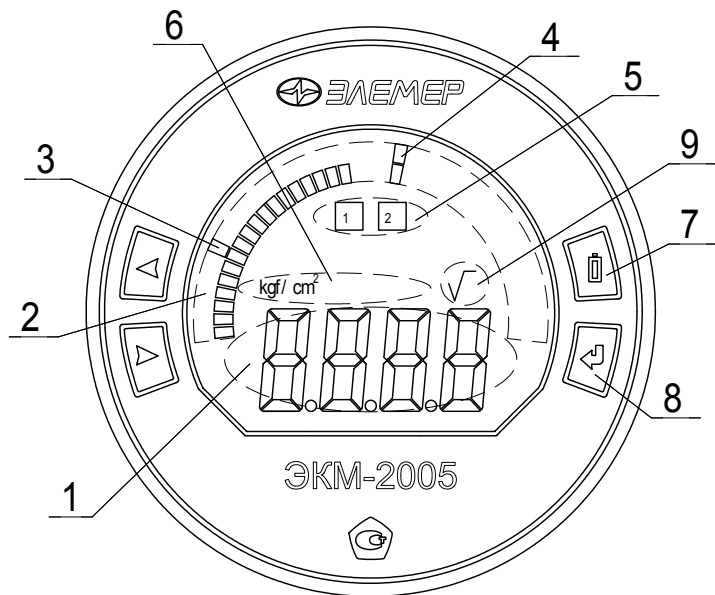

N o t e s — Key «», is set in ЭКМ when incorporated battery is present.

Front panel of ЭКМ-2005



Picture 2.5

Designations to the picture 2.5:

- 1 – field of the main indicator;
- 2 – field of the scale indicator;
- 3,4 – designation of the settings position on the scale indicator;
- 5 – field of indication of relay operation;
- 6 – field of indication of measurement units;
- 7 – key «», is present only when inbuilt battery is present;
- 8 – keys «», «», «»;
- 9 – field of indication of square-rooting.

2.3.3.1 The main display is the four digit seven segment LCD-indicator with 19 mm high symbols and it is designed for indication of:

- magnitudes of measured value;
- the name of menu item /configuration parameter;
- value of parameter configuration;
- diagnostic error reports.



Depending on the code of the order LCD- indicator of ЭКМ may be negative with lighting (LN) – light symbols on the dark background, or positive with lighting (LP) – dark symbols on the light background. Basic version – indicator of negative type.

2.3.3.2 Scale indicator represents a semicircle linear scale, consisting of 39 segments, and it is designed for indication and visual estimation of the current magnitude of measured value in the determined range of measurement. If the measured value exceeds the range of measurement for 0,2 %, last segments of the scale, corresponding to the lower and upper limit of the range of conversion of input signal starts blinking. The values of settings are presented on the scale indicator in the form of longer segments.

2.3.3.3 Within the indication field of relay operation the number of switched on relay is presented.

2.3.3.4 Within the indication field of measuring units the mnemonic name of set measurement units is presented.

2.3.3.5 When square-rooting function is operating on the display one can see a mnemonic designation «√».

2.3.3.6 The key «» is designed for short time (up to 30 sec) switching on of power supply from the incorporated battery when power supply voltage is absent. When pressing and holding the key «» during 2 seconds on the display is presented the result of the current pressure measurement, meanwhile the relay of signaling channels, lighting of LCD-indicator and current output will not operate. When manufacturing ЭКМ with the function of additional power supply is used an indicator of positive type (LP) – dark symbols on the light background. The resource of the battery suffices for four hundred operations of ЭКМ.

2.3.3.7 Keys «», «», «» are designed for:

- entering (exiting) menu;
- navigation in the menu;
- editing of values of configuration parameters;
- assignment settings values, hysteresis, dwell of relay, settings testing.

2.3.4 Contacts 1, 2, 3 of connector XP1 are designed for connecting signaling channels: 1 – general, 2 – output of the first channel of signalization, 3 – output of the second signaling channel. Power supply voltage is fed to contacts 1 and 4 of ЭКМ.

2.3.4.1 Contacts 1 (+) and 2 (-) of the connector XP2 are designed for connection to the current output of ЭКМ.

2.3.5 Reconstruction of the limits of the range of measurement of ЭКМ is performed in the following order:

- using instructions in the item 2.4 and item 2.5, configuration of ЭКМ is performed in accordance with the required sub-range of measurement (parameters of menu «OdPL», «OdPH», «PrcS», «Unit»);
- zero excessive pressure is fed to the input for ЭКМ-2005-ДИ, ЭКМ-2005-ДИВ, or zero absolute pressure (absolute pressure at the input should not exceed 0,05 % of the upper limit of measurement) for ЭКМ-2005-ДА, or zero difference of pressure – for ЭКМ-2005-ДД;
- with the help of parameter «SHFn» the value of indicator reading is set, corresponding to the lower limit of measurement range;
- excessive pressure is fed to input (for ЭКМ-2005-ДИ, ЭКМ-2005-ДИВ), absolute pressure (for ЭКМ-2005-ДА), or difference of pressures (for ЭКМ-2005-ДД), the values of which correspond to set upper limit;
- with the help of the parameter «GAin» is set the value of readings of indicator, corresponding to the upper limit of measurement range;
- adjustment of «zero» is repeated and adjustment of the range up to receiving of measurement error in accordance with item 2.2.1.

Notes — When performing above indicated procedures it is recommended to use a complex of verification pressures and standard signals of «ЭЛЕМЕР -ПКДС-210».

2.4 Navigation by menu

2.4.1 Review and variation of values of parameters, determining operation of ЭКМ, is performed in menu mode. Modified value of parameter is stored in nonvolatile memory and it operates immediately after editing is accomplished. When entering the menu mode the process of measurement and regulation does not stop.



2.4.2 The list of parameters of configuring has double level structure. The upper level – menu and lower level – sub-menu (see table 2.22).

2.4.3 The key «» is designed for entering the mode of settings values assignment, hysteresis, delay of relay operation, settings test, menu parameters, as well as for entering (recording) renewed values of parame-

ters into the memory of microprocessor unit of ЭKM. In the mode of changing of the selected parameter the current value of parameter starts blinking, after entering (recording) blinking stops.

2.4.4 The key «» is designed for review (selection) of settings and hysteresis towards an increase, selection of menu parameters forward and changing parameters values towards increase.

2.4.5 The key «» is designed for entering the configuration mode of ЭKM, review (selection) of settings and hysteresis towards decrease, selection of parameters of menu backwards and changing of values of parameters towards decrees.

2.4.6 Setting (editing) of number values of parameters is performed by keys «», «» in two modes: single –step and scanning.

Single-step mode – single pressing and release of the key, as a result of that the value of a parameter is changed for one unit of lower significant order.



Scanning mode – changing of parameter value by pressing and holding the key in depressed position. When holding the pressed key changing of the value is performed bit-by-bit, starting form the lower order and ending by the higher order. Meanwhile the value of every order is changed for ten units, starting from the current value. After changing of the value of the current order for ten units there is a transfer to scanning of the next high order.



















Scanning is stopped:





- when releasing the key;
- when reaching the upper limit (9999) or lower (-1999 for the limits of conversion and settings, 0 – for hysteresis, damping time and relay soak of upper values of values of numerical range;
- when changing over to decimal point to the neighboring digit.



N o t e s – For expedition of setting of parameters values it is recommended preliminary to decrease the number of digits after comma, by changing parameters «PrcS».



After stopping scanning a new parameter value starts blinking. For recording of renewed into the memory of ЭKM it is necessary to press the key «».

2.4.7 Entering the mode of configuring is executed by simultaneous pressing of keys «», «» or key «» for the time over 1 sec. On the display ЭKM there appear the report «UPAS» - request for input of a password (if the password is set for editing parameters). After pressing any



key (besides ) on the display will appear a blinking zero. Using keys ,  set the numerical value of the password (whole number from the range from 1 to 9999) and press the key . On display there will be the first item of the main menu «InP» (see table 2.21), if the password is introduced incorrectly. If the password is introduced incorrectly, then when the key  is pressed on the indicator during 1 s is displayed the report «Acde», denoting prohibition to edit parameters (only review is permitted), after that there will be the report «InP». If the password was not set (is equal to 0), the report «InP» will appear immediately after simultaneous pressing keys ,  or the key  for the time of over 1 sec. Using the keys ,  select the required item of the main menu according to table 2.21. In case of a password loss, it is reset by simultaneous pressing the keys , ,  and holding them in pressed state during 15 seconds. After pressing and holding the keys , ,  during 10 seconds there will appear the report «UPAS» and after more 5 seconds of keys holding, the password set before will be annulled with automatic transfer into the mode of editing password for setting a new password value. If keys , ,  or one of the keys are released before the moment of transit into the mode of editing, annulment of a password will not take place.

2.4.8 Transit from the main menu to the submenu is performed by pressing the key . Using keys ,  select the required parameter of the submenu and press the key  for entering the mode of changing parameter's values, the current parameter's value will start blinking.

2.4.9 In the mode of parameter values changing with the help of the key  or  set the desired value. Press the key . Blinking of a parameter will stop, and the value set will be recorded in ЭКМ memory.

2.4.10 If the password is introduced incorrectly, the instrument will make it possible to enter the mode of values review, but when attempting to change value of a parameter by keys ,  on indicator of ЭКМ will appear the message «Acde» - access denied. After pressing the key  the value of the parameter will not change.

2.4.11 Return from the mode of submenu to the main menu and from the main menu to the mode of measurement is done by selection of the parameter «rEt» and by pressing the key .

2.4.12 The quick return to the mode of measurement from any from any level of menu is performed by simultaneous pressing the keys ,  under condition that that the meaning of the parameter on the indicator does not blink (that is the mode of parameter editing is not switched on). The instrument will return to the mode of measurement, having presented meanwhile on the display during 1 second the message «Ain».

The instrument also returns to the mode of measurement without keeping the changes in case of not pressing the keys during 3 minutes (automatic exit).

Table 2.21 - Menu structure

Item of the main menu	Submenu	Name of the parameter	Notes
InP		Configuration of input parameters of ЭKM	Entrance into the menu of setting parameters of ЭKM input
	PrcS	Number of digits after comma	0, 1, 2 or 3
	ldPL	Lower limit of the range of measurement of ЭKM	The present parameter is set during manufacturing and corresponds to the model ЭKM, it is accessible only for inspection
	ldPH	Upper limit of the range of measurement of ЭKM	This parameter is set only during manufacturing and corresponds to the model ЭKM, it is accessible only for inspection
	Unit	Measuring units	Selection from the list of measuring units, displayed on the indicator
	t_63	Damping time	Is set within the range from 0 to 255 seconds
	Sqr	Function of square rooting	Switching on/ Switching off of the function of square-rooting (On/OFF)
	SHFn	Zero correction	Correction of lower limit of the range of measurement of manometer
	GAin	Range correction	Correction of upper limit of the range of measurement of manometer
	rEt	Exit from submenu	
rLY1		Configuration of parameters of relay 1 operation	

Continuation of the table 2.21

Main submenu item	Submenu	Parameter setting	Notes
	rL1.1	Connection of relay 1 with setting 1	OFF – relay condition does not change, StP1 – relay is on, if the measured value is less than that of the setting and (setting «lower»), StP2 – relay is on, if the measured value is higher than that of the setting (setting «upper»)
	rL1.2	Connection of relay 1 with setting 2	See description of parameter « rL1.1 »
	rL1.C	Relay 1 condition in case of exceeding the limits of measurement range	ON – switched on, OFF – switched off
	rEt	Exit from submenu	Return command to the main menu
rLY2		Configuration of parameters of relay 2 operation	
	rL2.1	Connection of relay 2 with setting 1	See description of parameter « rL1.1 »
	rL2.2	Connection of relay 2 with setting 2	See description of parameter « rL1.1 »
	rL2.C	Condition of relay 2 in case of exceeding the limits of measuring range	On – switched on, OFF – switched off
	rEt	Exit from submenu	Command of return into the main menu
Out		Configuration of output parameters of ЭKM	Entrance into menu of parameter setting of ЭKM output
	OtYP*	Range of current output	Selection of the range of unified current signal
	OdPL	Lower limit of the sub-range of measurement of ЭKM	Lower limit of conversion for current output
	OdPH	Upper limit of the sub-range of measurement of ЭKM	Upper limit of conversion for current output
	ErEn*	Permission of current of error	On - switched on OFF - switched off
	OErr*	Value of current of error	Error current for output unified signal in mA
	rEt	Exit from submenu	Command of return into the main menu
UPAS**		Password setting	Values from 0 to 9999
	rEt	Exit from menu	Command of return to measuring mode
Notes 1 * Parameter is displayed in case of set module of current exit. 2 ** Factory setting 0.			

2.5 Setting of parameters of configuration of ЭKM

2.5.1 Parameters of configuration of ЭKM and factory settings are presented in the table 2.22.

Table 2.22 – Parameters of configuration of ЭKM

Name of parameters	Designation on LCD display	№№ in order	Tolerable values of parameter	Factory setting
Number of digits after comma	PrcS	2.5.2	0, 1, 2 or 3	*
Lower limit of the range of measurements of ЭKM	IdPL	2.5.3	-1999...9999	*
Upper limit of the range of measurements of ЭKM	IdPH	2.5.3	-1999...9999	*
Measuring units	Unit	2.5.4	none, kgf/cm ² , MPa, kPa	*
Damping time	t_63	2.5.5	0...255	0,1
Function of square-rooting	Sqr	2.5.6	On – switched on OFF - switched off	OFF
Zero correction	SHFn	2.5.7	+2,5 %	-
Range correction	GAin	2.5.8	+2,5 %	-
Setting 1	SEt1	2.5.9	-1999...9999	-
Setting hysteresis 1	HYS1	2.5.10	0...9999	-
Relay 1 soak	trL1	2.5.11	0...255	0,1
Setting 2	Set2	2.5.9	-1999...9999	-
Setting hysteresis 2	HYS2	2.5.10	0...9999	-
Relay 2 soak	trL2	2.5.11	0...255	0,1
Connection of relay 1 with setting 1	rL1.1	2.5.12	OFF – absent StP1 – «for lowering » StP2 – «for increase »	StP2
Connection of relay 1 with setting 2	rL1.2	2.5.12	See description of parameter «rL1.1»	OFF
Condition of relay 1 when exceeding the limits of range of measurement	rL1.C	2.5.13	On – switched on OFF - switched off	OFF
Connection of relay 2 with setting 1	rL2.1	2.5.12	See description of parameter «rL1.1»	OFF
Connection of relay 2 with setting 2	rL2.2	2.5.12	See description of parameter «rL1.1»	StP2
Condition of relay 2 when exceeding the limits of range of measurement	rL2.C	2.5.13	On – switched on OFF - switched off	OFF

Continuation of the table 2.22

Name of parameters	Designation on LCD display	№№ in order .	Tolerable values of parameter	Factory setting
Range of current output	OtYP	2.5.14	Selected from the list 0-5, 0-20, 4-20, OFF	4-20
Lower limit of the range of measurements of ЭKM	OdPL	2.5.15	-1999...9999	*
Upper limit of the range of measurements of ЭKM	OdPH	2.5.15	-1999...9999	*
Permission of current of error	ErEn	2.5.16	On – switched on OFF - switched off	On
Value of current of error	OErr	2.5.16	Value of current within the range – 0...6, 0...22,5, 3.7...22,5 mA	3,7
N o t e — * Factory setting corresponds to the order form.				

2.5.2 Number of digits after coma «PrcS» – maximal number of digits after comma for displaying on LCD-indicator of value. Measured value of pressure is represented in the form of the number with fluctuating decimal point, which is automatically displaced to the right at increasing of the value of measured parameter due to limited capacity of LCD -indicator. Tolerable values - 0, 1, 2, 3.

2.5.3 Lower and upper limits of the measuring range «IdPL», «IdPH»: tolerable values from -1999 to +9999. Range is set when manufacturing ЭKM in accordance with the range of measuring of a sensor. These parameters are available for consumers only for review, when attempting to edit parameter the message - «AcdE» is produced.

2.5.4 Units of measurements «Unit» – physical units of measurement of input signal, displayed on the LCD – indicator. Selected from the list - non, kgf/cm², MPa, kPa. When changing units of measurement an automatic recalculation of the number of digits after comma, measuring limits of ЭKM, limits of conversion of current output, magnitudes of settings and hysteresis to selected units of measurement.





2.5.5 Damping time «t_63» - constant of time of the filter of first order, parameter making it possible to reduce variation (noises) of measurement. Setting the value of this parameter it is necessary to take into account the fact that in case of a step variation of pressure for 100 % from the range of measurements, output signal will reach the value of 63 % from the range measurement zone of measurement during the time, set in parameter «t_63». Tolerable values from 0 to 255 sec. Discreteness of values setting - 0,1 sec for interval from 0 to 1 sec and 1 sec for interval from 1 to 255 sec. When set-

ting the values of parameters on the display will appear the symbol «c» - seconds.





2.5.6 The function of square rooting «Sqr» – parameter, permitting square rooting from the measured pressure. If the parameter has the meaning «OFF» – switched off, then measurement is performed by linear law. When function of square rooting is switched on display there will appear symbols «√» and «%». Indication range and the range of conversion of measured value for current output will be equal to 0...100 %. Range of measured pressure with normalized error will be equal from 6,25 to 100 % for pressure difference, set by parameters «OdPL» and «OdPH», a range of measured expenditure will be within the range from 25,0 to 100,0 %.

For decrease of noises near zero at input pressure less than 1 % from the range of measurement is used the linear function of conversion.

2.5.7 Correction of zero «SHFn» causes displacement of the zero of ЭКМ. For zero displacement it is necessary to feed to the input of ЭКМ zero excessive pressure for ЭКМ-2005-ДИ, ЭКМ-2005-ДИВ, or zero absolute pressure (absolute pressure at the input should not exceed 0,05 % upper limit of measurement) for ЭКМ-2005-ДА, or zero difference

of pressures – for ЭКМ-2005-ДД. With the help of keys «», «» (less, more) is set the value of ЭКМ readings, corresponding to supplied pressure. For reset of introduced displacement it is necessary in the present menu to simultaneously press keys «», «». The possible value of zero displacement amounts to $\pm 2,5$ % of the upper range of measurement of ЭКМ.

2.5.8 Correction of the range «GAin» causes the variation of the range of measurement of ЭКМ. For correction of the range it is necessary to feed to the input of ЭКМ excessive (for ЭКМ-2005-ДИ, ЭКМ-2005-ДИВ), or absolute pressure (for ЭКМ-2005-ДА), or difference of pressures (for ЭКМ-2005-ДД), corresponding to preset upper limit. With the help of

keys «», «» (less, more) is set the value of readings of ЭКМ, corresponding to supplied pressure. For reset of introduced displacement it is necessary in the present menu simultaneously press keys «», «». Possible value of correction of the range amounts to $\pm 2,5$ % from the upper range of measurements of ЭКМ.

2.5.9 «SEt1», «SEt2» – values of the first and second settings, set in units of measured value. ЭКМ has got two independent comparators of settings, which may be tuned for operation with executive relay of two signaling channels.

2.5.10 Hysteresis of settings «HYS1», «HYS 2» – the value of delay of settings switching off, set in units of measured value, is used for de-

creasing «bounce» of contacts. Parameter have always positive value. Switching off delay is asymmetrical relative to the value of a setting. The setting «for lowering» is switched on at $A \leq \text{Set}$ and switched off at $A \geq \text{SEt} + \text{HYS}$, setting «for heightening» is switched on at $A \geq \text{Set}$ and is switched off at $A \leq \text{SEt} - \text{HYS}$, where A – is a measured value.

2.5.11 The values of delay of relay operation «trL1», «trL2» – parameters, protecting for misoperation in conditions of interferences and fast processes. Parameters set the delay time for switching on for operation of every relay. After operation of the setting the countdown of time of delay of relay operation starts, meanwhile the symbol of relay switch on starts blinking. After countdown of delay of active setting the relay will switch on, blinking of the symbol of relay operation will stop. If during countdown the setting is switched off – countdown is stopped, the timer will display zero and the relay switches off. Tolerable values from 0 to 255 sec. Discreetness of values setting - 0,1 sec for an interval of fro 0 to 1 sec and 1 sec for interval from 1 to 255 sec. When setting the value of parameter on display will appear the symbol «c» - second. These parameters make it possible in ЭКМ the function of time relay with exposure time from 0 to 255 sec. for every channel of signaling. In the instrument there is the program delay when power supply of ЭКМ is switched on of 10 seconds duration. During countdown of delay at LCD – indicator the number of relay will start blanking, which should switch on in accordance with active setting.

2.5.12 Connection of relay with settings «rL» – parameter, determining logics of relay operation. In the table 2.23 the values of parameter of relay connection with conditions of settings comparators are presented.

Table 2.23 – Connection of relay with settings

Value of parameter of connection of relay with settings	Type of setting
OFF	Connection of relay and settings are absent
StP1	Setting «for lowering», relay is switched on, if the measured value is less than the setting
StP2	Setting «for heightening», relay is switched on, if the measured value is more than the setting

Factory settings «rL1.1» - «StP2», «rL1.2» - «OFF», «rL2.1» - «OFF», «rL2.2» - «StP2».

2.5.13 Condition of relay at exit of the signal beyond the limits of measurement range «rL1.C», «rL2.C» - parameter, which may have two meanings of the value: «OFF» - switched off or «On» - switched on. If the value of parameter - «OFF», relay is switched off at the exit of the signal beyond the limits of the range of measurements, if «On» – switched on. Factory setting «OFF».

2.5.14 Range of current output «OtYP» - parameter, in which the range of unified current output is determined: «0-5» - output 0...5 mA, «0-20» - output 0...20 mA, «4-20» - output 4...20 mA, «OFF» - current output is switched off. Parameter is available in the menu only when the module of current output is available in the instrument.

2.5.15 Lower and upper limits of the sub-range of measurement «OdPL», «OdPH» - parameters determine the range of indication and the range of conversion for current output. The value of the sub-range should be located inside the range of measurements, preset during manufacturing of ЭKM by parameters «IdPL» and «IdPH». Tolerable values from -1999 to +9999.

2.2.15.1 Lower limit of the sub-range «OdPL» (A_H) – number, which is presented in accordance with the lower limit of sub-range measured pressure and current output.





2.2.15.2 Upper limit of the sub-range «OdPH» (A_B) – number, which is presented in accordance with the upper limit of the sub-range of measured pressure and current output.

2.5.16 «ErEn» and «OErr» - determine the operation mode of current output during exit of pressure beyond the range of measurements. The parameter «ErEn» permits formation of current of error. Tolerable value of parameter «OFF» - current of error is switched off, «On» – switched on. Parameter «OErr» assign the value of the current of error depending on the range of current output preset in parameter «OtYP». Current of error should have value from 0 to 6 mA for current output 0...5 mA, from 0 to 22,5 mA for current output 0...20 mA, from 3,7 to 22,5 mA for current output 4...20 mA. Parameters «ErEn» and «OErr» in menu are available in only in case of presence of the module of current output in the instrument.



2.6 Assignment of magnitudes of settings, settings testing.

2.6.1 Assignment (scanning) of settings, hysteresis, relay soak, settings testing.



2.6.1.1 Press the key . On the display of ЭKM there will appear the reading «UPAS» - request for introduction of a password (if a password for editing of parameters was set). Press any key, blinking zero will appear.



Using keys ,  set the digital value of a password (whole number within the range from 1 to 9999) and press the key . On display parameter «SEt1» will appear, if password is set correctly. If the password is set in the wrong way, when pressing the key  on display during 1 s the report «AcD» will appear, denoting prohibition of editing of parameters (only reading is permitted), after that the report «SEt1» will appear. If the password was not set (equal to 0), then the report «SEt1» will appear immediately after pressing the key .







2.6.1.2 By keys ,  make selection of required parameter.

With the help of the key  selection of parameters is performed in cycles forward: «SEt1» → «HYS1» → «SEt2» → «HYS2» → «trL1» → «trL2» → «tEst» → «rEt» → «SEt1», with the help of the key  in cycles backwards: «SEt1» → «rEt» → «tEst» → «trL2» → «trL1» → «HYS2» → «SEt2» → «HYS1» → «SEt1».



«SEt1» и «SEt2» - values of settings, «HYS1» и «HYS2» - hysteresis values, «trL1», «trL2» - values of delays of relay operation, «tEst» - entrance into the mode of settings testing, «rEt» - command of return into the mode of measurement.



2.6.1.3 For measuring of settings values, hysteresis or delay, select the required parameter, press the keys  for entrance into the mode of measuring of parameter value, the value of parameter will start blinking. With the help of keys ,  set the required value of the parameter.

Press the key . Blinking of parameter will stop, and the set value will be recorded into the memory of ЭKM. If the value of parameter does not change, press the key , at this the present value will remain.

2.6.1.4 For entering of settings and relay testing mode select the parameter «tEst» and press the key , after that relay switching off will take place irrespective of the state of measured value. By keys , , «tSt1» - test of the first setting, «tSt2» - test of the second setting, «tStF» - test of relay in case of measured value exceeding the limits of the measurement range. With the help of the key  selection of parameters happens in cycles forward: «tSt1» → «tSt2» → «tStF» → «rEt» → «tSt1», with the help of the key  in cycles backward: «tSt1» → «rEt» → «tStF» → «tSt2» → «tSt1». Having chosen parameter «tSt1» or «tSt2», press the key  for entering the mode of setting testing. After this ЭКМ will switch to the mode of emulation of measured value near the value of the setting, meanwhile emulated value will start blinking. When reaching the magnitude of setting by emulated value there will happen operation of setting and relay connected with this setting, with consideration of preset hysteresis, of damping time and time of delay of relay operation.

For expedition of the process of relay testing, time of damping and the time of delay of relay operation it is recommended to set in the zero value (parameters «t_63», «trL1» and «trL2»).

Having selected the parameter «tStF», press the key , there will appear a blinking report «-FL-» - exceeding by the measured value the range of measurement. Meanwhile relay operation will take place in accordance with the meaning «OFF» - switched off or «On» - switched on, set in parameters «rL1.C», «rL2.C». For ending of the current test press the key . For exiting the mode of testing select parameter «rEt» and press the key , there will appear the report «tEst».

2.6.1.5 After ending of settings testing, testing of settings value entering, hysteresis, the time of keys holding ,  select the command «rEt» and press the key . The instrument will keep introduced changes in the memory and will return in the mode of measuring, having indicated meanwhile on the display during 1 second the reading «A in».

The instrument also returns to the measuring mode if keys are not pressed during 3 minutes (automatic exit). In the mode of testing of relay the time of automatic exit is increased with consideration of values of parameters «trL1», «trL2» and «t_63».

2.7 Error reporting

2.7.1. In ЭKM it is envisaged a possibility to produce reports on condition of the instrument and errors appearing in the process of operation. Possible error reports and their description are provided in the table 2.24.

Table 2.24 – Error reporting

Text reports	Error content
«nrdY»	Appears from the moment of switching on of ЭKM until the end of data handling during preparation of correct results of measurement
«Lo»	Measured pressure is in the range from minus 1,88 to minus 1,25 % of the sub-range of measurements
«AcdE»	Password is entered incorrectly
«Hi»	Measured pressure is within the range from 112,5 to 115,6 % of sub-range of measurement
«Cut»	Input pressure is less than minus 1,88 % of the range of measurement or a sensor is out of order.
«FI»	Measured pressure is more than 115,6 % sub-range of measurement or sensor is out of order.

Note – In case of malfunctioning of ЭKM there appears the report «Err». If this reading does not disappear after switching off (for the time not less than 3 s) and repeated switching on of ЭKM – servicing of ЭKM is required, which is performed in the manufacturing enterprise.

2.8 Marking

2.8.1 Marking of ЭKM is performed in accordance with STATE STANDARDS 26828-86 E, STATE STANDARDS 22520-85, drawings HKГЖ.406233.030СБ and appendix Б.

2.9 Packaging

2.9.1. Packaging is performed in accordance with STATE STANDARDS 23170-78E and it ensures complete safety of ЭKM.

2.9.2. Packaging of ЭKM is performed in closed premises at the temperature of ambient air from plus 15 to plus 40 °C and relative humidity 80 % at absence in the surrounding media of aggressive substances.

2.9.3. Prior to packaging the holes of connecting pipes are closed by caps, safeguarding the internal chamber from getting dirty and thread from mechanical damage.

3. USE OF INSTRUMENTS ACCORDING TO FUNCTION

3.1. Preparation of instruments for operation

3.1.1 Instructions of security measures

3.1.1.1. Safety of ЭKM operation is ensured by:

- durability of measuring chambers, which correspond to norms provided by item 2.2.1;
- insulation of electrical circuits in accordance with norms provided by items 2.2.27 - 2.2.28.2;
- reliable fixation during mounting on the object;
- design (all components of ЭKM, are under voltage and placed in a housing providing protection of service personnel from touching components and units that are alive).

3.1.1.2. As to the method of protection of personnel from electric current trauma ЭKM with voltage power supply of 220 V corresponds to class I in accordance with STATE STANDARDS 12.2.007.0-75

3.1.1.2.1. As to the method of protection from electrical current of ЭKM with voltage power supply of 24 V or 36 V corresponding the class III in accordance with STATE STANDARDS 12.2.007.0-75.

3.1.1.3. Grounding is performed by means a screw with washers, located in the housing of ЭKM.

3.1.1.4. When testing ЭKM it is necessary comply with general requirements of safety in accordance with STATE STANDARDS 12.3.019-80, and when operating - «Regulations of technical operation of electrical operation of electrical appliances of consumers» and «Safety standards when operating electrical appliances of consumers» for appliances of up to 1000 W voltage, approved by Gosenergonadzor.

3.1.1.5. ЭKM should be maintained by personnel, having qualification group as to safety measures not less than II according to « Safety standards when operating electrical appliances of consumers».

3.1.1.6. When testing insulation it is necessary to take into consideration safety requirements for testing equipment.

3.1.1.7. Changing, connection and disconnection of ЭKM from main lines, supplying measured media, should be done after closing ventilation on the line prior to ЭKM and disconnection of electrical power supply. Disconnection of ЭKM should be performed after pressure release in ЭKM down to atmospheric pressure.

3.1.1.8. ЭKM-2005A (of increased reliability) in accordance with НП – 001 – 97 (ОПБ – 88/97) belong to the class of safety 2, 3, 4:

- according to purpose – to elements of normal operation;
- according to influence on safety – to elements, important for safety;

– according to the character of functions performed – to elements of safety control systems.

Example for classification designation 2HY, 3H or 4H.

3.1.1.9. ЭКМ-2005А is fire-proof, that is a possibility of fire in ЭКМ-2005А does not exceed 10^{-6} per year in accordance with STATE STANDARDS 12.1.004-91 in normal as well as in emergency modes of operation of Nuclear Stations. Fire is open fire on external surfaces of converters or a burst of burning particles on them.

3.1.1.10. When testing and operating ЭКМ-2005А it is necessary also it is necessary to comply with requirements of НП – 001 – 97 (ОПБ-88/97), НП – 082 – 07.

3.1.2 External inspection

3.1.2.1 During external inspection absence of mechanical damage is determined, correspondence of marking is determined as well as complete set.

In case of any defects, affecting operation ability of ЭКМ, inadequacy of complete set, marking it is determined if it is possible to use them thereafter.

3.1.2.2 Every ЭКМ is checked for availability of a passport with the marking of Quality Control Department.

3.1.3 Testing

3.1.3.1 Connect ЭКМ to power supply and measuring instrument in accordance with pictures 3.1-3.4.

3.1.3.2 Hold ЭКМ in switched on condition during 5 minutes.

3.1.3.3 Verify operation ability of ЭКМ by readings of display and measuring instrument.

3.1.3.4 In case of need set required range of measurements, using instructions of item 2.3.5.

3.1.3.5 Check and in case of need make adjustment of «zero», for that:

- Supply to the input zero excessive pressure for ЭКМ-2005-ДИ, ЭКМ-2005-ДИВ, or zero absolute pressure (absolute pressure at input should not exceed 0,05 % of the upper limit of measurement) for ЭКМ-2005-ДА, or zero difference of pressures – for ЭКМ-2005-ДД;
- with the help of parameter «SHFn» are set values of indicator readings corresponding to the lower limit of measurement range.

3.1.3.6 Check and in case of need make adjustment of upper limit of measurement for that purpose:

- Supply to output excessive pressure for ЭКМ-2005-ДИ, ЭКМ-2005-ДИВ, or absolute pressure for ЭКМ-2005-ДА, or difference of pressures - for ЭКМ-2005-ДД, corresponding to determined upper limit;
- with the help of parameter «GAin» set the values of indicator readings corresponding to upper limit of measuring range;
- repeat procedures according to item 3.1.3.5, if adjustment of “zero” was performed than it is necessary to repeat procedures According to item 3.1.3.6.

N o t e s – When performing above operations it is recommended to use the complex of verification pressure and standard signals produced by «ЭЛЕМЕР-ПКДС-210».

3.1.3.6.1 Adjustment of upper and lower limits is required, when setting upper and (or) lower limit of measurements, different from factory ones.

3.1.3.6.2 Factory setting of the range of measurement is provided in the technical certificate of ЭКМ.

**Diagram of electrical connections of ЭКМ-2005
without current output with voltage of power supply ~ 220 V
or = 220 V**

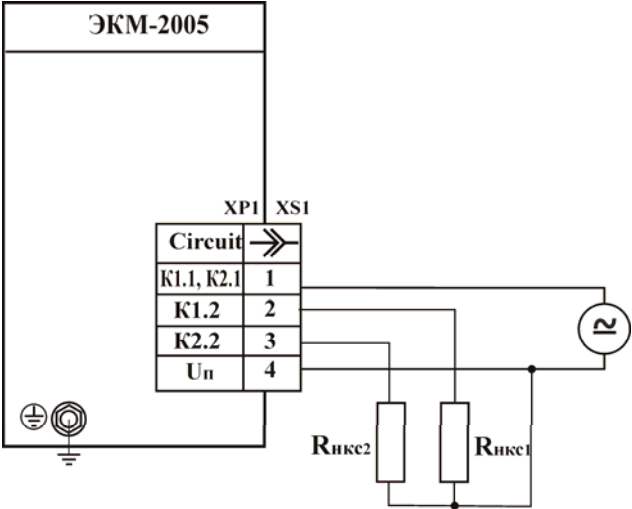

Picture 3.1

**Diagram of electrical connection of ЭКМ-2005
without current output with power supply voltage = 24 V or = 36 V**

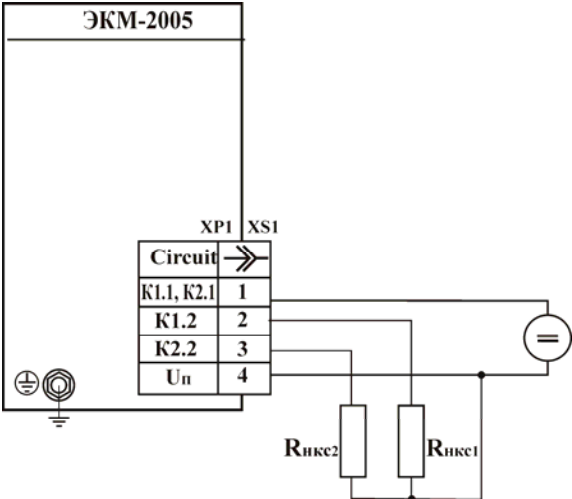

Picture 3.2

**Diagram of electrical connections of ЭКМ-2005
with current output of ~ 220 V or = 220 V**

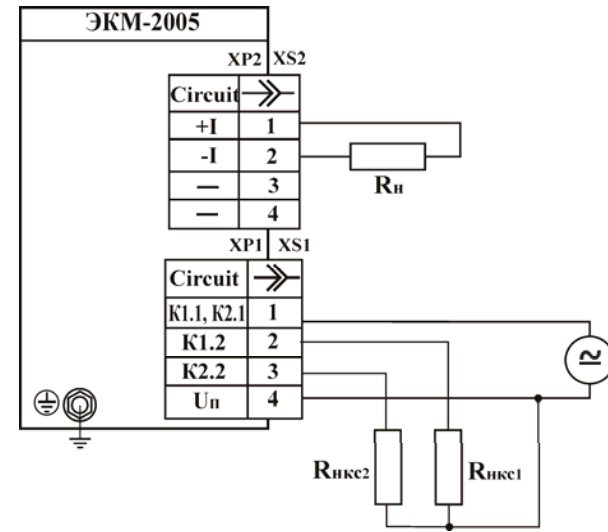

Picture 3.3

**Diagram of electrical connection ЭКМ-2005
with current output with power supply voltage = 24 V or = 36 V**

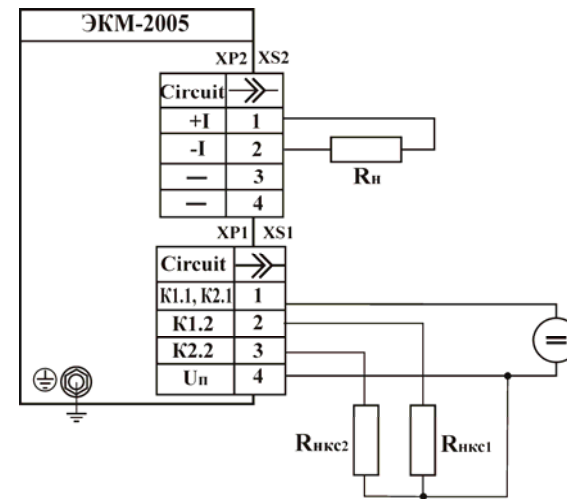

Picture 3.4

**Diagram of electrical connection of ЭКМ-2005
without current output with power supply voltage ~ 220 V and = 220 V
with galvanic uncoupled circuits of power supply commutation**

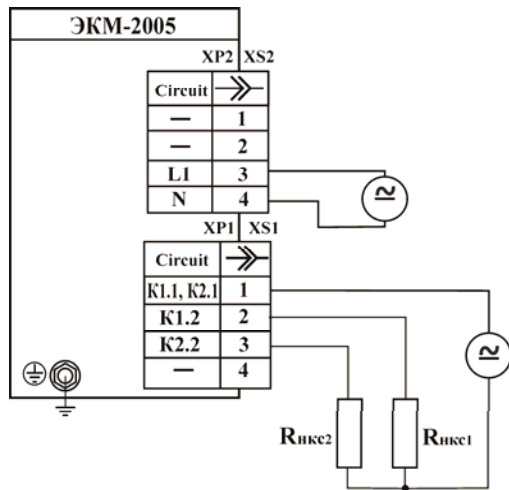

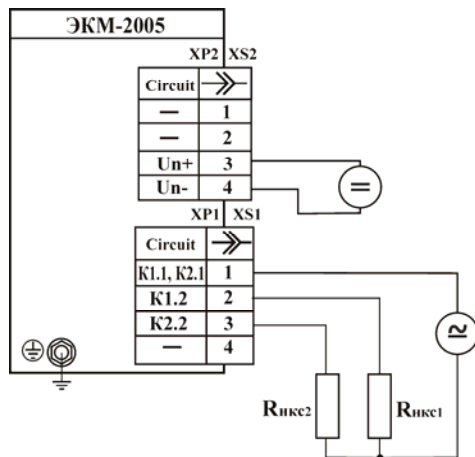

Picture 3.4.1

**Diagram of electrical connection of ЭКМ-2005
without current output with power supply voltage = 24 V or = 36 V
with galvanic uncoupled circuits of power supply commutation**



Picture 3.4.2

Designations for pictures 3.1 - 3.4.2:

- XP1 – GSP 311 (Type A)
- XS1 – socket GDM 3009 (Type A)
- XP2 – plug GSSNA 300 (Type C)
- XS2 – socket GDSN 307 (Type C)
-  – alternate current power supply source (110...249 В) or direct current (150...249 V) (for power supply of ЭКМ and signaling channels)
-  – direct power supply source (18...40 V) (for power supply of ЭКМ and signaling channels)
- РНКС – power supply in circuits of signaling channels

Disposition of plugs contacts

Plug GSSNA 300

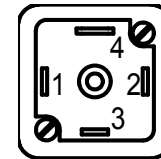

Plug GSP-311

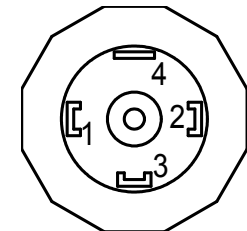

Plug 2PMГ 14 (ШП 14)

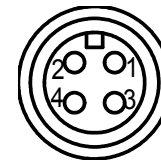

Plug 2PMГ 22 (ШП 22)

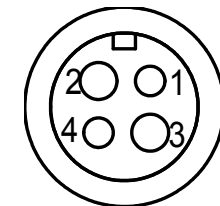

Picture 3.5

**Electrical diagram of signaling channels connection
of ЭKM-2005**

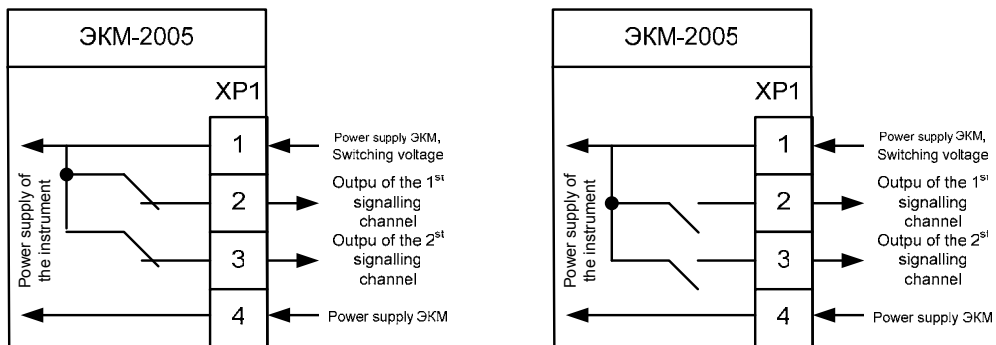

For variant of execution of
Signaling instruments III

For variant of execution of
Signaling instruments IV

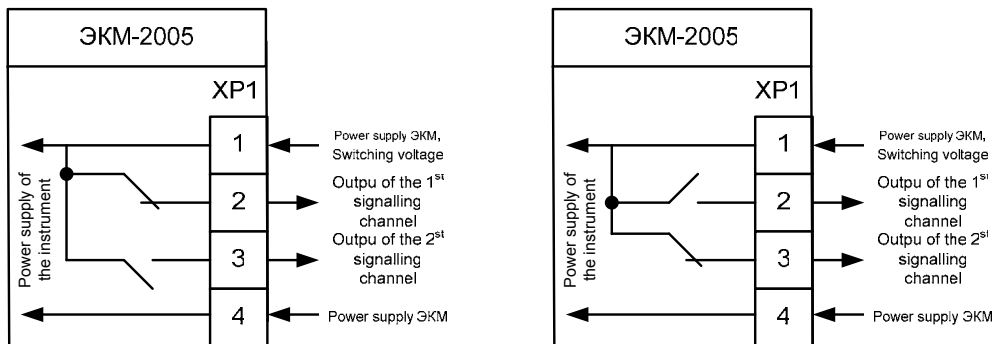

For variant of execution of
Signaling instruments V

For variant of execution of
Signaling instruments VI

When operating ЭKM from alternate current of 220 V, to contact 1 is supplied the phase, and to contact 4 – the neutral of power supply voltage.

Voltage supplied to the contact 1 is commuted, contact 4 is general for commuted voltage.

Picture 3.6

3.1.4 Instruments installation

3.1.4.1 ЭKM is installed in the position, convenient for operation and servicing.

3.1.4.2 When selecting the place of installation of ЭKM it is necessary to consider the following:

- places of installation of ЭKM should provide comfortable conditions for servicing and dismantling;
- temperature, relative humidity of ambient air, vibration parameters should not exceed the values provided in the section «Technical characteristics» of the present operation manual;
- intensity of magnetic fields, caused by external sources of alternate current with frequency of 50 Hz, should not exceed 600 A/m;
- connection of ЭKM to power supply and commutation circuits is performed by one wire or multiple strand to power supply and to commutation circuits it is performed by one wire or multiple strand wire with section of 0,35...0,7 mm²;
- for provision of reliable operation of ЭKM in conditions of hard electromagnetic situation electrical connections should be performed by twisted pairs or twisted pairs in the screen. Screen should be grounded at this.

3.1.4.3 Directly in front of ЭKM should be installed either a three-way valve or a one-way valve assembly, calculated for corresponding parameters of media.

If pressure of measured medium is over 0,3 MPa and the length of pulse line over 3 m a shutoff valve should be installed at the place of pressure tap.

It is necessary to lay connecting lines to instruments in such a way as to prevent gas blocks (when measuring pressure of liquid) or hydraulic pockets (when measuring pressure of gas).

Prior to switching on of ЭKM into operation ventilation unit situated before the unit should be closed until filling of the connection line by cooled liquid.

Connection to trunk line pipelines should be made on three areas where the flow has the highest speed and flowing is without any turbulence, that is at a sufficient distance from connecting elements and bends.

3.1.4.4 When measuring pressure of aggressive gas, as well as pressure of aggressive or viscous fluid separating vessels are installed into pulse lines.

3.1.4.5 Pulse lines should not have abrupt bends and they should be laid from the major pipeline to pressure converter with an incline not less

than 1:10. Pulse lines from the place pressure tap to ЭKM must be laid by the shortest way. The length of the line should be enough for the temperature of the media supplied to ЭKM, not to exceed tolerable temperature of ambient air. Recommended length – should be not more than 15 m.

Pulse lines should have one-sided incline (not more than 1:10) from the point of pressure tap, upwards to ЭKM, if measured media – gas and downwards to ЭKM if measured media is – liquid.

For horizontal or inclined pipelines pipe-bend of pulse line in the place of inset into pipeline should be located (see the picture 3.7):

- a) horizontally either declined from horizontal line downwards for an angle from 0° to 45° – when measuring liquid pressure;
- б) horizontally either deviated from horizontal line upwards for an angle from 0° to 45° – when measuring pressure of vapor;
- в) vertically either deviated from horizontal line downwards or for an angle from 0° to 45° – when measuring pressure of vapor.

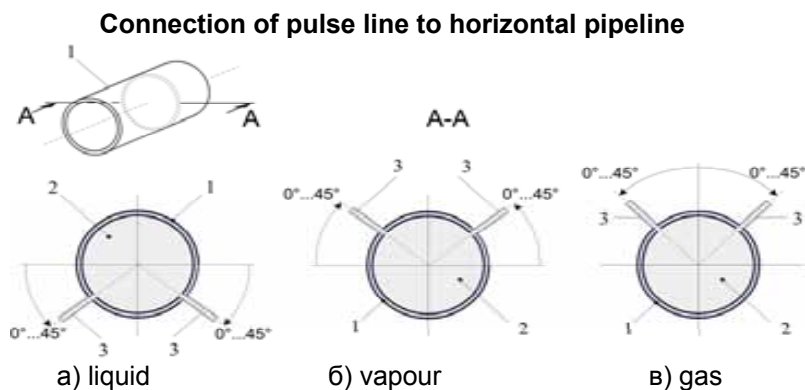

Picture 3.7

Designations to the picture 3.7:

- 1 – pipeline;
- 2 – measured media;
- 3 – bend of pulse line.

If it is impossible when measuring pressure of gas pressure when in the lower points of pulse line it is required to install settling vessels, and when measuring pressure of liquid in the highest points – gas collectors. When measuring pressure of humid negative gas in the lowest point of pulse line is placed condensate gathering tank.

It is recommended to install settling vessels in front of ЭКМ and in other cases, especially in case of long connecting lines and in case of positioning of ЭКМ lower than the place of pressure tap.

Prior to connection to ЭКМ the line should be thoroughly blown out for decrease of possibility of soiled chambers of measuring unit of ЭКМ.

Connection of ЭКМ to pulse line is performed with the help of complete set of mounting components (by separate order).

For blowing connection lines special devices are envisaged.

3.1.4.6 For protection of ЭКМ from hydraulic impacts, as well as during changing pressure in the media with a large level of pulsing, it is recommended to place in front of ЭКМ a damping device ДУ in accordance with the catalogue produced by SPC «ELEMER».

3.1.4.7 Grounding of the housing of ЭКМ, for this purpose the wire with cross section not less than 1 mm^2 should be connected to the contact \perp of the housing ЭКМ.

3.1.4.8 After connection of ЭКМ to measured media «zero» should be checked, if necessary adjustment should be performed, the procedure of adjustment of «zero» is determined in item 3.1.3.5.

3.1.4.9 Electrical mounting of ЭКМ-2005 should be performed in accordance with diagrams of electrical connections (see pictures 3.1 – 3.4).

3.2. Use of instruments

3.2.1. When supplying measured pressure P to an input of ЭКМ, its value is determined by readings of the indicator in corresponding units of measurements.

In case of presence in ЭКМ of current output of pressure values are determined by the formula:

$$P = \frac{(I - I_H)}{(I_B - I_H)} \cdot (A_B - A_H) + A_H, \quad (3.1)$$

where I_B и I_H – decoded in item 2.2.5

A_B и A_H – decoded in item 2.2.3.

3.2.2 In order to change batteries, located in the module of power supply and relay, it is necessary:

- unwind four screws of fastening of the rear wall to the housing;
- remove rear wall;
- change the battery (type - 23A, 12 V);
- make assembly of ЭКМ in reverse order.

3.2.1.1 General view of the power supply and relay module

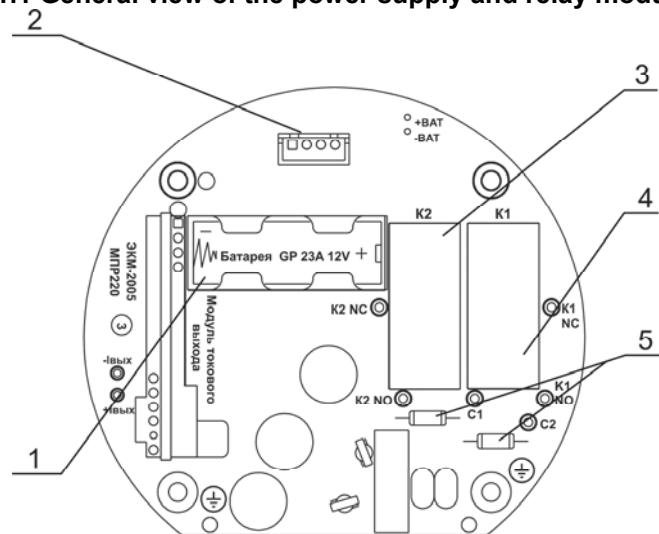

Picture 3.8

Designations to the picture 3.8:

- 1 – battery compartment;
- 2 – connector block for connection to PC (used only during instrument manufacture);
- 3 – relay of the second signaling channel;
- 4 – relay of the first signaling channel;
- 5 – safety devices in the circuit of power supply of ЭКМ.

3.2.3 In case of sensor module of ЭКМ failure, it is possible to replace module in operational conditions, for this purpose it is necessary to perform the following operations:

- unwind four screws of fastening of the rear wall to the housing;
- remove rear wall of ЭКМ;
- unwind four supports, fixing the module of power supply and relay;
- disconnect contact of housing grounding;
- remove the power supply order and relay from the housing together with the rear wall ;
- unsolder wires of the sensor module from contacts 1, 2, 3 on the system module (XP1, picture 3.9);
- loosen the screw, fixing module of sensor in the housing, and unscrew the module (the screw is under seal);
- install the new module in the housing and fix by a screw;

- solder the wires of sensor module to contacts 1, 2, 3 on the system module (XP1, picture 3.9);
- assembly ЭКМ in reverse order;
- make adjustment of the limits of the range of measurement of ЭКМ, using instructions of item 2.3.5;
- make verification using instructions of the chapter 4 of the present operation manual.

General view of the system module

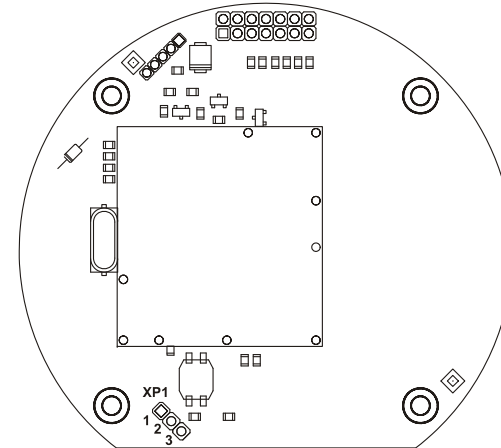

Picture 3.9

Designation fro the picture 3.9:

- 1 – contact for soldering the blue wire of sensor module (voltage U_{in});
- 2 - contact for soldering of black wire of sensor module (grounding);
- 3 - contact for soldering of red wire of sensor module (power supply +5 V).

3.2.4 During inductive load in circuits of commutation (for voltage of power supply ≈ 220 V), it is recommended to install parallel to relay contacts контактам реле spark suppression circuits. Spark suppression circuit should consist of cascade connection of a resistor with nominal 50...100 Ohm 0,5 Wt and a capacitor 10...100 μ A for nominal voltage not more than 1 kV.

4. CALIBRATION METHODS

4.1 Calibration of electronic manometers ЭКМ-2005 is performed by bodies of State metrological service or other accredited bodies according to ПР 50.2.014-2003 for the right of calibration of an organization. Requirements to organization, the order of calibration procedure and the form of presentation of calibration results are determined in accordance with ПР 50.2.006-94 «GSI. Calibration of measuring instruments. Organization and procedure order».

4.2 Recalibration interval is equal to three years.

4.3 The present methods may be used for calibration of ЭКМ.

4.4 Operation and calibration instruments.

4.4.1 When performing calibration the following operations should be performed, provided in the table 4.1.

Table 4.1

№ in order	Calibration procedures	Item number	Обязательность проведения операции при	
			Primary calibration	Periodical calibration
1	External inspection	4.7.1	Yes	Yes
2	Verification of tightness of the system	4.7.2	Yes	Yes
3	Test run	4.7.3	Yes	Yes
4	Testing of electrical durability of insulation	4.7.4	Yes	No
5	Testing of electrical resistance of insulation	4.7.5	Yes	Yes
6	Determination of the basic reduced error	4.7.6	Yes	Yes
7	Treatment of calibration results	4.7.7	Yes	Yes
8	Validation of calibration results	4.7.8	Yes	Yes

4.4.2 During calibration the main and auxiliary calibration instruments should be employed, provided in the table 4.2.

Table 4.2

№ in order	Name of instruments of calibration and designation of НТД	Основные метрологические и технические характеристики средства поверки
1	Calibration complex of pressure and standard signals «ЭЛЕМЕР-ПКДС-210» ТУ 4381-071-13282997-07	Range of measurement of current : 0...25 mA, limits of tolerable basic absolute error $\pm 0,003$ mA. Upper limits of pressure measurement from 10 кПа to 60 МПа, Limits of tolerable basic error from $\pm 0,03$ to 0,3 %
2	Unit for verification of electrical safety GPI-745A	Range of output voltages from 100... to 5000 V
3	Megaohmmeter Ф4102/1-1М ТУ25-75340005	Range of measurement of resistance: 0...20000 MOhm
4	Thermometer digital portable ТЦМ 9410 ТУ 4211-065-13282997-05	Measurement range 0...100 °C Resolution 0,1 °C Limit of tolerable error $\pm 0,3$ °C
<p>Notes</p> <p>1 The manufacturing company of ИКСУ-260, ПДЭ-010 as a component of ЭЛЕМЕР-ПКДС-210 is SPC «ELEMER».</p> <p>2 All enumerated in the table 4.2 measuring instruments should have actual calibration certificates.</p> <p>3 It is permitted some freshly developed calibration instruments as well as those in operation and equipment, that are according to their characteristics are not inferior to the ones provided I the present calibration methods.</p>		

4.5 Safety regulations

4.5.1 During calibration safety regulations provided in documentation for used calibration instrument and equipment.

4.6 Conditions of calibration and preparation for it

4.6.1 When performing calibration the following conditions are observed:

- 1) temperature of ambient air, °C 23 ± 2 ;
- 2) relative air humidity, % $30 \div 80$;
- 3) atmospheric pressure, kPa (mm of merc.column) $84,0 \div 106,7$ (630 – 800);
- 4) power supply voltage depending on execution, V $36 \pm 0,72$;
 $24 \pm 0,48$ or 220 ± 5 ;

- 5) pulsing of voltage of power supply does not exceed $\pm 0,5\%$ of the value of power supply voltage;
- 6) load resistance, OHm: 500 ± 50 (for 36 V)
or 250 ± 25 (for 24 V);
- 7) actuating medium for ЭKM with upper limits up to 2,5 mPa including – air or neutral gas, more 2,5 mPa - liquid; it is possible to use liquid when calibrating ЭKM with upper limits of measurement from 0,4 to 2,5 mPa under condition that the system is completely filled with liquid;
- 8) external electrical and magnetic fields should be absent or remain within the limits not affecting operation of ЭKM;
- 9) vibration, shocks, affecting operation of ЭKM in the process of verification, should be absent.

4.6.2 Operations performed with instruments of calibration and calibrated ЭKM, should be performed in accordance with instructions provided in operation manual and other documentation.

4.6.3 Prior to calibration operations the following preparation operations should be performed:

4.6.3.1 ЭKM is held in conditions presented in items 4.6.1.1)...4.6.1.3) during 3 hours .

4.6.3.2 Holding ЭKM prior to calibration after switching on power supply during 30 minutes.

4.6.3.3 ЭKM is set in operational position.

4.7 Calibration procedure

4.7.1 External inspection of calibrated ЭKM is performed in accordance with items 3.1.2 of the present operation manual.

4.7.2 Verification of the system tightness

4.7.2.1 Verification of the system tightness is performed at the pressure value equal to maximal upper limit of measurement of calibrated ЭKM in accordance with tables 2.6 - 2.12.

4.7.2.2 During verification of the system tightness, designed for calibration of ЭKM, instead of the calibrated ЭKM is installed a converter which tightness has been verified already or any other instrument, having an error (reduced to values of pressure, presented in item 4.7.2.1) not more than 2,5 % and making it possible to fix pressure variation, equal to 0,5 % of the pre-set pressure value.

Create pressure, presented in item 4.7.2.1, and pressure source is switched off. If as a standard СИ is used the deadweight pressure system, its column and press is switched off.

The system is considered to be tight, if after three minute holding under pressure, equal to upper limit of measurement, during last 2 minutes there will be no pressure drop.

When temperature of ambient air is changed and the temperature of measured medium within the limits ± 1 °C variation of pressure is permissible not exceeding the values provided in the table 4.3. Total time of exposure to pressure may be increased up to 15 minutes, meanwhile variation of pressure during 5 minutes should exceed the values provided in the table 4.3.

Table 4.3

Upper limit of measurement		Tolerable variation of pressure during verification, % of the upper limit of measurements	
kPa	mPa	Pneumatic pressure	Hydraulic pressure
4,0; 6,0; 10	-	$\pm 3,5$	-
16; 25	-	$\pm 1,2$	-
40; 60; 100; 160; 250; 400; 600	1,0; 1,6; 2,5; 4,0; 6,0	$\pm 0,6$	± 10
-	10; 16; 25; 40; 60	-	± 5
Note — In case of less variation of temperature the tolerable variation of pressure is proportionally decreased.			

4.7.2.3 If the system designed for calibration of ЭКМ with different values of upper limits of measurements, testing of tightness should be performed under pressure, corresponding to the biggest of these values.

4.7.3 Testing

When testing calibrated ЭКМ their operation ability are tested in accordance with 3.1.3 of the present operation manual, meanwhile current is measured with the help of ИКСУ as a component of the complex «ЭЛЕМЕР -ПКДС-210».

Verification of tightness of ЭКМ is recommended to combine with the operation of determination of the basic error.

Method of tightness verification of ЭКМ is analogous to the methods of verification of system tightness. In case of detection of tightness leakage in the system with calibrated ЭКМ, it is required to test separately the system and ЭКМ.

4.7.4 Verification of durability of electrical insulation

Verification of durability of electrical insulation is performed between the contacts for connection of voltage to housing with the help of installation of GPI-745A, permitting to rise voltage of uniformly by steps, not exceeding 10 % of the value of testing voltage.

Verification voltage should be increased starting from zero or from the value not exceeding nominal voltage of the circuit, up to testing voltage during not less than 30 sec.

Error of measuring of verification voltage should not exceed ± 5 %.

Insulation is held under influence of verification voltage during 1 minute. After that voltage is decreased down to zero or the value not exceeding the nominal one after that the testing unit is switched off.

Insulation of ЭКМ circuits should withstand complete verification voltage without breakdowns and surface overlapping.

Verification of electrical durability is performed during verification voltages presented in items 2.2.28.

4.7.5 Verification of electrical resistance of insulation

Verification of electrical resistance of insulation is performed between contacts for connection of voltage and housing with the help of mega-ohmmeter Ф4102/1-1М. Resistance of insulation of ЭКМ should not be less than 20 MΩ during verification voltage, presented in item 2.2.27.

4.7.6 Determination of basic reduced error

4.7.6.1 With the help the pump from the complete set of pressure and standard signals «ЭЛЕМЕР-ПКДС-210» is formed the pressure at the input of ЭКМ. Measured pressure at this is supplied directly to the standard module of pressure ПДЭ-010 and to the calibrated ЭКМ. For indication of pressure value, measured by ПДЭ-010, using ИКСУ or РС. The value of pressure measured with the help of ПДЭ-010И, is displayed on the indicator of ПДЭ-010И or on the monitor of РС. The value of pressure measured by calibrated ЭКМ, is displayed on LCD indicator and ИКСУ is subtracted from the value of output current signal of ЭКМ.

4.7.6.2 The basic error of ЭКМ is determined as a maximal deviation of measured values of readings ПДЭ-010 (ПДЭ-010И).

4.7.6.3 Verification is performed at the points corresponding 0 (5), 25, 50, 75 и 100 (95) % of measurement range.

4.7.6.4 Basic error is determined at the value of measured pressure, received at approaching to it from the side of smaller, as well as from the side of greater values (at direct and reverse trace).

4.7.6.5 Prior to verification in case of reverse trace of ЭКМ is held during 5 minutes under influence of upper maximal value of pressure.

4.7.7 Treatment of calibration results

4.7.7.1 Basic reduced error of readings of measured value, $\gamma_{\text{унд}}$, is calculated from the formula

$$\gamma_{\text{унд}} = \frac{P_{\text{унд}} - P_{\text{э}}}{P_{\text{в}} - P_{\text{н}}} \cdot 100\%, \quad (4.1)$$

where $P_{\text{унд}}$ - the pressure value, displayed on LCD indicator of ЭКМ;
 $P_{\text{э}}$ - the value of pressure in the system measure by standard instrument;
 $P_{\text{в}}$ и $P_{\text{н}}$ - upper and lower limits of measurement of pressure.

The greater from calculated values of the basic reduced error of indication should not exceed corresponding values presented in the tables 2.6 - 2.12.

4.7.7.2 When using «ЭЛЕМЕР-ПКДС-210» the main reduced error of current output of ЭКМ $\gamma_{\text{д}}$, is calculated from the formula

$$\gamma_{\text{д}} = \frac{P - P_{\text{э}}}{P_{\text{в}} - P_{\text{н}}} \cdot 100\%, \quad (4.2)$$

where P - the value of pressure, measured by ЭКМ and displayed on LCD -indicator of ИКСУ;
 $P_{\text{э}}$ - the value of pressure in the system measured by standard instrument ПДЭ-010 (ПДЭ-010И);
 $P_{\text{в}}$ и $P_{\text{н}}$ - upper and lower limits of pressure measurement.

In case of simultaneous connection of ЭКМ and ПДЭ to ИКСУ, the values of error will be reflected on LCD display of ИКСУ. The largest of the received values of the basic reduced error should not exceed the value computed in accordance with item 2.2.4.

4.7.7.3 When using other measuring instruments the basic reduced error γ_{I} is calculated from the formula

$$\gamma_{\text{I}} = \frac{I - I_{\text{р}}}{I_{\text{в}} - I_{\text{н}}} \cdot 100\%, \quad (4.3)$$

where I - measured value of output current, mA;
 $I_{\text{р}}$ - calculated value of output signal, corresponding to calibrated value of measured pressure and is computed by formula of item 2.2.5, mA.

The greatest from computed values of the basic reduced error should not exceed the value computed in accordance with item 2.2.4.

4.7.8 Registration of calibration results

4.7.8.1 Positive results of calibration of ЭKM is documented by the record in the technical certificate, certified by a controller and authorized by an imprint of the stamp or preparation of a certificate on verification according to the form of Appendix 1 to ПП 50.2.006-94.

4.7.8.2 In case of negative results of calibration ЭKM is not permitted for operation. For this ЭKM is written a notification about no operability by the form of Appendix 2 to ПП 50.2.006-94.

5. TECHNICAL MAINTENANCE

5.1. Technical maintenance of ЭKM come to following the operation instructions, storage and transportation, presented in the present operation manual, maintenance inspections, periodical calibration and repair work.

5.2. Maintenance inspections are performed in the order provided at the objects of operation of ЭKM, and it includes:

- 1) Internal inspection;
- 2) Testing of tightness of the system (in case of need);
- 3) Testing of durability of ЭKM fixation, durability of cable connection and absence of rupture of grounding wire;
- 4) Verification of functioning, (including verification of signaling channels);
- 5) Verification of the value of output signal of ЭKM, corresponding to zero value of measured pressure in accordance with item 3.1.3.

5.3. Periodical calibration of ЭKM is performed not less than one time during three years in accordance with instructions provided in the section 4 of the present operation manual.

5.4. ЭKM with malfunctioning, not possible to remedy during maintenance inspection, or that ones which did not pass periodical testing, are liable for current repair.

Repair of ЭKM is performed at the manufacturing factory.

6. STORAGE

6.1. Conditions of storage of ЭKM in transport tare in a warehouse of the manufacturer and a consumer should correspond with conditions 3 according to STATE STANDARDS 15150-69.

There should be no aggressive ingredients in the air.

6.2. Disposition of ЭKM in warehouses should provide an easy access to it.

6.3. ЭKM should be stored on the shelving.

6.4. Distance between the walls, floor warehouse and ЭKM should be not less than 100 mm.

7. TRANSPORTATION

7.1. ЭKM are transported by all types of transport in covered transport vehicles. Fixation of tare in transportation vehicles should be performed in accordance with regulations, operational for corresponding types of transport.

7.2. Conditions of transportation of ЭKM should correspond to conditions 5 according to STATE STANDARDS 15150-69 at the temperature of ambient air from minus 50 to plus 60 °C with consideration of protection measures from shocks and vibration.

7.3. ЭKM should be transported packed in packets or individually.

7.4. ЭKM should be transported in boxes according to STATE STANDARDS 21929-76 requirements.

8. UTILIZATION

Utilization of manometers is performed according to instruction of an operating organization.

APPENDIX A

Electronic manometers ЭКМ-2005

Samples of recording designation when ording

ЭКМ-2005 – АЭС – 2 – ДИ – ИК6М / 4.0 МПа – D – V – LN – t0550 – 220 – 42 – /-/ –

1 2 3 4 5 6 7 8 9 10 11 12 13

GSP – BC/5M – M20 – 13V – T1Φ – KP1 – / 360П / – ΠΠ – ТУ 4212-082-13282997-09

14 15 16 17 18 19 20 21 22

1. Type of manometer
2. Execution version (table 2.1)
Basic version — general industrial
3. Safety class for the execution type with the code of execution when ordering A, АЭС: 2, 3 or 4.
4. Type of measured pressure:
 - absolute — ДА
 - excessive — ДИ
 - excessive pressure - depression — ДИВ
 - difference of pressures — ДД
5. Conditional designation of the model (tables 2.6 – 2.16)
6. Upper limit (range) of measurement (tables 2.6 – 2.16) and measurement units: Па (Pa), кПа (kPa), МПа (MPa), bar, kgs/sm² (kgf/cm²), kgs/m², mm of water column.
7. Code precision class: B, C, D (table 2.6 – 2.16)
Basic version – D
8. Code of execution of signaling instrument (table 2.2)
Basic version — V
9. Code of the type of an inbuilt LCD –indicator:
 - negative with lighting – code LN
 - positive – code LP
 - in case of presence of reserve power supply source is used only positive LCD –indicationBasic version – LN
10. Code of climatic execution (tables 2.5, 2.5.1)
Basic version – code t0550
11. Power supply voltage:
 - ~ 220 V or = 220 V – 220
 - ~ 220 V or = 220 V with galvanic uncoupled circuits of power supply and commutation (current of exit is absence) – 220Г
 - = 24 V or = 36 V – 24
 - = 24 V or = 36 V with galvanic uncoupled circuits of power supply and commutation (current output is absent) – 24ГBasic version – code 220

12. Present of current output :
- absent «—»
 - present – 42
- Basic version* – code «—»
13. Presence of reserve power supply source (batteries):
- absent «—»
 - present – Б
- Basic version* – code «—»
14. Code of variant of electric connection (table 2.4)
- Basic version* – code GSP
15. Constructive version:
- "BC" – with external sensor of the pressure converter with indication of the cable length (for possibility of external location of the sensor module and indication module).
- Basic version* - without external sensor.
16. Code of connection to the process (connector thread) (table 2.16)
- Basic version* – код M20.
- Attention* — for ЭКМ-2005-ДД (nipple joint to the process) should be indicated only code «M20»
17. Code of designation of execution by materials (tables 2.17-2.19)
- Basic version* – в таблице 2.19
18. Code of complete set of mounting components (КМЧ) for connection to the process (table A.2):
- for ЭКМ-2005-ДА, ДИ, ДИВ
- Basic version* – code T1Ф
- for ЭКМ-2005-ДД
- Basic version* – code T1Ф (2 pcs.)
19. Code of mounting holder (table A.1):
- Basic version* – absent
20. Additional bench-test during 360 hours (index of order – 360П)
21. State calibration (index of order — ГП)
22. Designation of specifications

ATTENTION! Obligatory for filling in are:

- Pos. 1 – type of converter
- Pos. 4 – type of measured pressure
- Pos. 5 – condition of model designation
- According to special order it is possible to manufacture ЭКМ with an offset sensor from electronic unit.

All positions that are not filled in will be basic.

Example of minimal filling in of the form of order:

ЭКМ-2005 – ДИ – ИК40
1 4 5

ORDER EXAMPLE

$\frac{\text{ЭКМ-2005}}{1} - \frac{-/-}{2} - \frac{-/-}{3} - \frac{\text{ДИ}}{4} - \frac{\text{ИК2,5М} / 2,5 \text{ МПа}}{5} - \frac{\text{D}}{6} - \frac{\text{V}}{7} - \frac{\text{LP}}{8} - \frac{\text{t0550}}{9} - \frac{220}{10} - \frac{42}{11} - \frac{\text{Б}}{12} - \frac{\text{GSP}}{13} -$

$\frac{-/-}{15} - \frac{\text{M20}}{16} - \frac{13\text{V}}{17} - \frac{\text{T1Ф}}{18} - \frac{\text{KP1}}{19} - \frac{-/-}{20} - \frac{\text{ГП}}{21} - \frac{\text{ТУ 4212-082-13282997-08}}{22}$

Table A.1 — Mounting bracket code

Type of ЭКМ	Bracket	Picture (see table A.2)	Code when ordering
ДА, ДИ, ДИВ, ДД	Non	—	—
	Bracket №1	1	KP1

Table A.2 — Mounting bracket code KP1

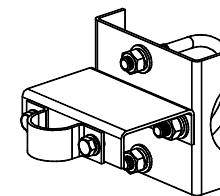

Picture 1

When ordering a bracket from steel AISi316 to the code of mounting components should be added the letter «H». For example, KP1H.

Continuation of appendix A

Table A.3 — Code of complete mounting components (KMЧ) for connection to the processes

Типе ЭКМ	Composition of KMЧ	Picture (see table 4)	Code of connection to process when ordering
ДА, ДИ, ДИВ	Gasket (Ф-4УВ15 or M1)*	2	T1Ф(М)
	Adopter with M20x1,5 for external thread M12x1,5, gasket (Ф-4УВ15 or M1)*	3	T2Ф(М)
	Adopter with M20x1,5 for internal thread K1/4" (1/4"NPT), gasket (Ф-4УВ15 or M1)*	4	T3Ф(М)
	Adopter with M20x1,5 for external thread K1/2" (1/2"NPT), gasket (Ф-4УВ15 or M1)*	5	T4Ф(М)
	Adopter with M20x1,5 for internal thread K1/4" (1/4"NPT), gasket (Ф-4УВ15 or M1)*	6	T5Ф(М)
	Adopter with M20x1,5 for internal thread K1/2" (1/2"NPT), gasket (Ф-4УВ15 or M1)*	7	T6Ф(М)
	Gasket M20x1,5, nipple, gasket (Ф-4УВ15 or M1)*	8	T7Ф(У) или T7М(У)**
	Buss M24x1,5 (for sensors with half opened membrane)	9	T8(У)**
	Buss M24x1,5, ring gasket (for sensors with half opened membrane)	10	T9(У)**
	Buss M39x1,5 (for sensors with half opened membrane)	11	T10(У)**
ДД	Gasket ((Ф-4УВ15 or M1) (2 pcs.)*	2	T1Ф(М)2
	Adopter with M20x1,5 for external thread M12x1,5 (2 pcs.), gasket (Ф-4УВ15 or M1) (2 pcs.)*	3	T2Ф(М)2
	Adopter with M20x1,5 for internal thread K1/4" (1/4"NPT) (2 pcs.), gasket (Ф-4УВ15 or M1) (2 pcs.)*	4	T3Ф(М)2
	Adopter with M20x1,5 for internal thread K1/2" (1/2"NPT) (2 pcs.), gasket (Ф-4УВ15 or M1) (2 pcs.)*	5	T4Ф(М)2
	Adopter with M20x1,5 for external thread K1/4" (1/4"NPT) (2 pcs.), gasket (Ф-4УВ15 or M1) (2 pcs.)*	6	T5Ф(М)2
	Adopter with M20x1,5 for external thread K1/2" (1/2"NPT) (2 pcs.), gasket (Ф-4УВ15 or M1) (2 pcs.)*	7	T6Ф(М)2
	Gasket M20x1,5 (2 pcs.), nipple (2 pcs.), gasket (Ф-4УВ15 or M1) (2 pcs.)*	8	T7Ф(У)2 или T7М(У)2**
<p>Notes</p> <p>1 * Ф-4УВ15 - for pressure up to 16 MPa, M1 – for pressure of more than 16 MPa.</p> <p>2 ** Nipple and busses are made of steel 12X18H10T. When ordering nipple or busses from carbon steel to code is added the letter «У».</p>			

Continuation of appendix A

Table A.4 — Complete set of mounting components (KMЧ) for connection to the process

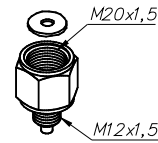
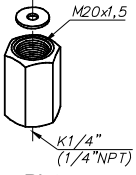
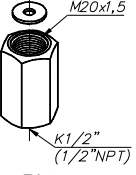
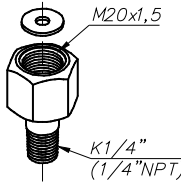
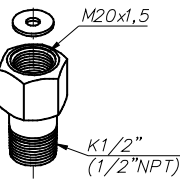
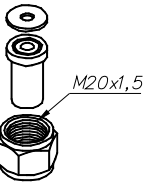
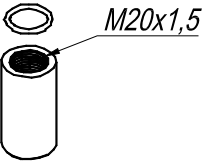
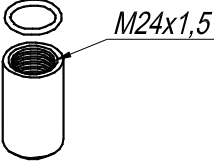
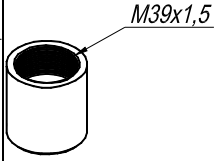
T1Φ (M)	T2Φ (M)	T3Φ (M)	T4Φ (M)
 <p>Picture 2</p>	 <p>Picture .3</p>	 <p>Picture .4</p>	 <p>Picture .5</p>
T5Φ (M)	T6Φ (M)	T7Φ(У) или T7M(У)	T8(У)
 <p>Picture .6</p>	 <p>Picture .7</p>	 <p>Picture .8</p>	 <p>Picture .9</p>
T9(У)	T10(У)		
 <p>Picture .10</p>	 <p>Picture.11</p>		

APPENDIX A.1

Module of electronic manometer ЭКМ-2005

Example of recording of designations when ordering

Sensor ЭКМ-2005 – /–/ – ДИ – ИК6М – Д – t0550 – M20 – 13V – ТУ 4212-082-13282997-08
1 2 3 4 5 6 7 8 9

1. Type of sensor module
 2. Execution type (table 2.1)
Basic version — general industrial
 3. Type of measured:
 - absolute — ДА
 - excessive — ДИ
 - excessive pressure-depression — ДИВ
 - difference of pressures — ДД
 4. Designation of the model (tables 2.6 - 2.12)
 5. Class of precision: B, C, D (tables 2.6 - 2.12)
Basic execution – D
 6. Code of climatic execution (table 2.5)
Basic execution – code t0550
 7. Code of connection to the process (connector thread) (table 2.16)
Basic execution – code M20
- Note:** for sensor ЭКМ-2005-ДД should show the code M20
8. Designation code of execution according to materials (tables 2.17-2.19)
Basic execution – in table 2.19
 9. Designation of technical conditions

APPENDIX B

Tags with marking
ЭKM-2005

Plug GSSNA 300
Plug GSP 311

Plug 2PMГ 14 (ШП 14)
Plug 2PMГ 22 (ШП 22)

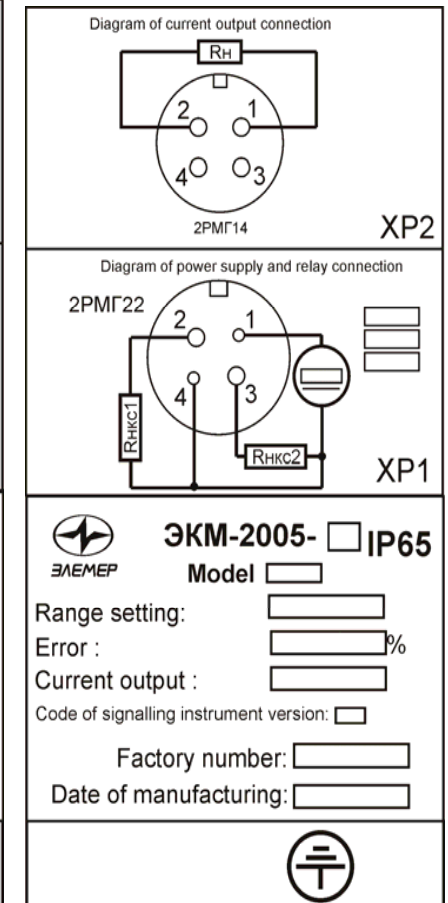
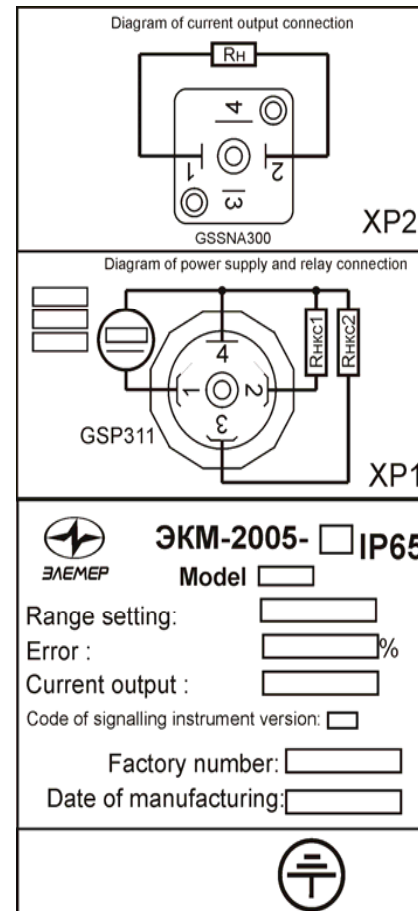

Picture B.1

Continuation of the Appendix Б.1

Tags with marking
ЭКМ-2005
 with galvanic uncoupling of circuits of power supply
 and commutation

Plug GSSNA 300
Plug GSP 311

Plug 2PMГ 14 (ШП 14)
Plug 2PMГ 22 (ШП 22)

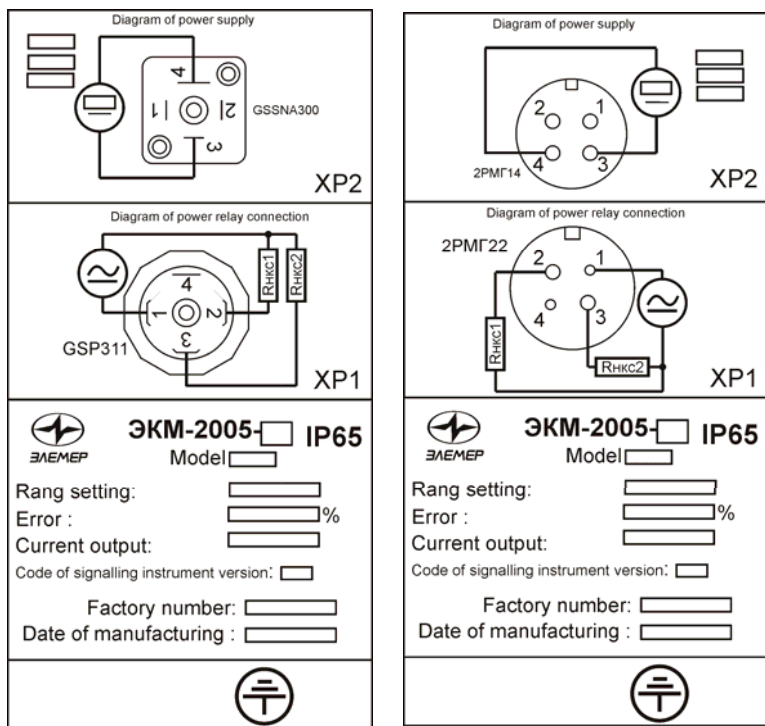

Picture Б.2

Continuation of the appendix B

Tag with marking
ЭKM-2005A

Plug GSSNA 300
Plug GSP 311

Plug 2PMГ 14 (ШП 14)
Plug 2PMГ 22 (ШП 22)

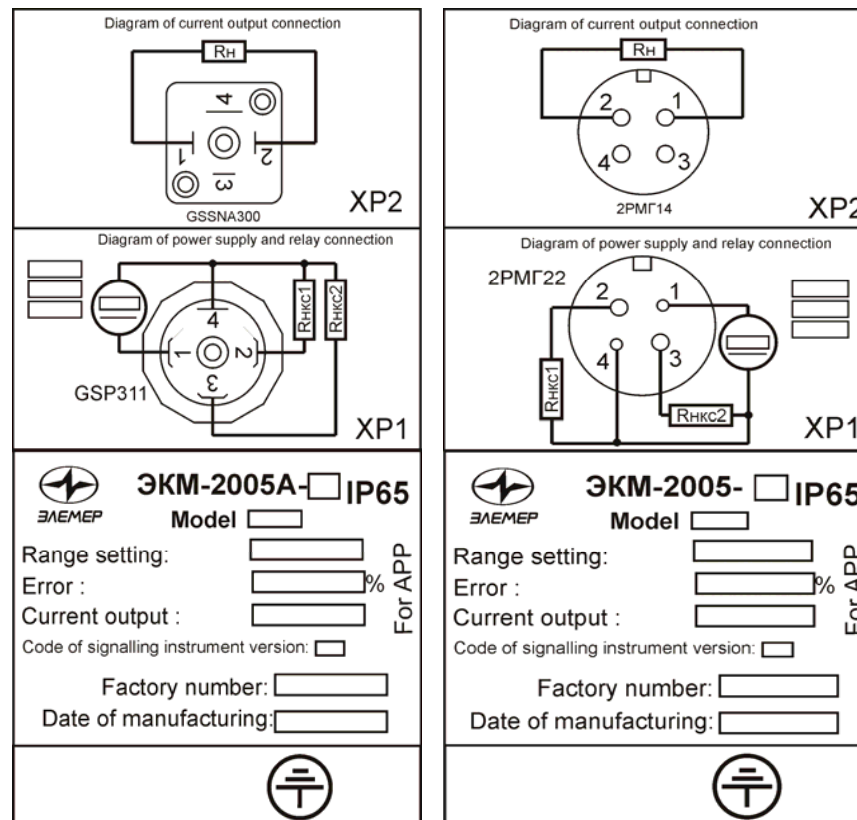

Picture B.3

Continuation of the appendix B

Tag with marking
ЭКМ-2005А
 with galvanic uncoupling of circuits of power supply
 and commutation

Plug GSSNA 300
 Plug GSP 311

Plug 2PMГ 14 (ШП 14)
 Plug 2PMГ 22 (ШП 22)

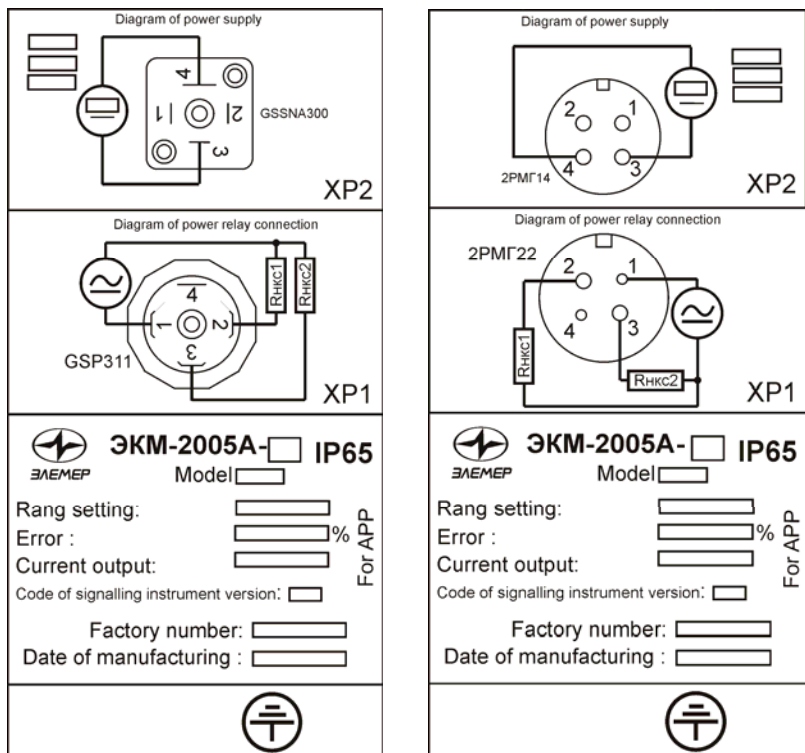

Picture B.4

20110125